

Conventional Protein Kinase C isoforms differentially regulate ADP- and thrombin-evoked Ca²⁺ signalling in human platelets

Robert A. Lever^a, Azhar Hussain^a, Benjamin B. Sun^a, Stewart O. Sage^a & Alan G.S. Harper^{a,b}

^aDepartment of Physiology, Development and Neuroscience, University of Cambridge, Downing Street, Cambridge, CB2 3EG, United Kingdom and ^bInstitute for Science and Technology in Medicine, Keele University, Guy Hilton Research Centre, Thornburrow Drive, Hartshill, Stoke-on-Trent, ST4 7QB, United Kingdom.

.

Running head: PKC in platelet Ca²⁺ signalling

Corresponding Author: Dr Alan Harper. Institute for Science and Technology in Medicine, Keele University, Guy Hilton Research Centre, Thornburrow Drive, Hartshill, Stoke-on-Trent, ST4 7QB U.K.

E-mail: a.g.s.harper@keele.ac.uk

Fax: +44 1782 747319

Telephone: +44 1782 674472.

Abstract

Rises in cytosolic Ca^{2+} concentration ($[\text{Ca}^{2+}]_{\text{cyt}}$) are central in platelet activation, yet many aspects of the underlying mechanisms are poorly understood. Most studies examine how experimental manipulations affect agonist-evoked rises in $[\text{Ca}^{2+}]_{\text{cyt}}$, but these only monitor the net effect of manipulations on the processes controlling $[\text{Ca}^{2+}]_{\text{cyt}}$ (Ca^{2+} buffering, sequestration, release, entry and removal), and cannot resolve the source of the Ca^{2+} or the transporters or channels affected. To investigate the effects of protein kinase C (PKC) on platelet Ca^{2+} signalling, we here monitor Ca^{2+} flux around the platelet by measuring net Ca^{2+} fluxes to or from the extracellular space and the intracellular Ca^{2+} stores, which act as the major sources and sinks for Ca^{2+} influx into and efflux from the cytosol, as well as monitoring the cytosolic Na^+ concentration ($[\text{Na}^+]_{\text{cyt}}$), which influences platelet Ca^{2+} fluxes via $\text{Na}^+/\text{Ca}^{2+}$ exchange. The intracellular store Ca^{2+} concentration ($[\text{Ca}^{2+}]_{\text{st}}$) was monitored using Fluo-5N, the extracellular Ca^{2+} concentration ($[\text{Ca}^{2+}]_{\text{ext}}$) was monitored using Fluo-4 whilst $[\text{Ca}^{2+}]_{\text{cyt}}$ and $[\text{Na}^+]_{\text{cyt}}$ were monitored using Fura-2 and SFBI respectively. PKC inhibition using Ro-31-8220 or bisindolylmaleimide I potentiated ADP- and thrombin-evoked rises in $[\text{Ca}^{2+}]_{\text{cyt}}$ in the absence of extracellular Ca^{2+} . PKC inhibition potentiated ADP-evoked but reduced thrombin-evoked intracellular Ca^{2+} release and Ca^{2+} removal into the extracellular medium. SERCA inhibition using thapsigargin and 2,5-di(tert-butyl) 1,4-benzohydroquinone abolished the effect of PKC inhibitors on ADP- evoked changes in $[\text{Ca}^{2+}]_{\text{cyt}}$ but only reduced the effect on thrombin-evoked responses. Thrombin evokes substantial rises in $[\text{Na}^+]_{\text{cyt}}$ which would be expected to reduce Ca^{2+} removal via the $\text{Na}^+/\text{Ca}^{2+}$ exchanger (NCX). Thrombin-evoked rises in $[\text{Na}^+]_{\text{cyt}}$ were potentiated by PKC inhibition, an effect which was not due to altered changes in non-selective cation permeability of the plasma membrane as assessed by Mn^{2+} quench of Fura-2 fluorescence. PKC inhibition was without effect on thrombin-evoked rises in $[\text{Ca}^{2+}]_{\text{cyt}}$ following SERCA inhibition and either removal of extracellular Na^+ or inhibition of Na^+/K^+ -ATPase activity by removal of extracellular K^+ or treatment with digoxin. These data suggest that PKC limits ADP-evoked rises in $[\text{Ca}^{2+}]_{\text{cyt}}$ by acceleration of SERCA activity, whilst rises in $[\text{Ca}^{2+}]_{\text{cyt}}$ evoked by the stronger platelet activator thrombin are limited by PKC through acceleration of both SERCA and Na^+/K^+ -ATPase activity, with the latter limiting the effect of thrombin on rises in $[\text{Na}^+]_{\text{cyt}}$ and so forward mode NCX activity. The use of selective PKC inhibitors indicated that conventional and not novel PKC isoforms are responsible for the inhibition of agonist-evoked Ca^{2+} signalling.

Key words: platelet, protein kinase C, calcium, sarco/endoplasmic reticulum Ca^{2+} -ATPase, Na^+/K^+ -ATPase

1. Introduction

The importance of rises in cytosolic Ca^{2+} concentration ($[\text{Ca}^{2+}]_{\text{cyt}}$) for the adhesion and aggregation of human platelets is well established, and this has encouraged significant interest in the molecular mechanisms underlying the creation and control of agonist-evoked rises in $[\text{Ca}^{2+}]_{\text{cyt}}$ in these cells. Most studies examine how experimental manipulation of channels, transporters or intermediate signalling proteins affect agonist-evoked rises in $[\text{Ca}^{2+}]_{\text{cyt}}$ in suspensions of Fura-2- or Fluo-4-loaded human platelets. Yet these studies are limited by their ability to only monitor the net effect of any experimental manipulation on each of the component processes involved in controlling $[\text{Ca}^{2+}]_{\text{cyt}}$ (Ca^{2+} buffering, sequestration, release, entry and removal), and lack the ability to resolve the source of the Ca^{2+} or the transporters or channels affected. Recent work in human platelets has highlighted the many pitfalls of drawing conclusions as to the molecular pathways involved in eliciting Ca^{2+} signals based solely on measurements of $[\text{Ca}^{2+}]_{\text{cyt}}$ [1-3].

A simple method for more accurately tracking the Ca^{2+} flux around the platelet is to measure the net Ca^{2+} fluxes to or from the extracellular space and the intracellular Ca^{2+} stores, which act as the major sources and sinks for Ca^{2+} influx into and efflux from the cytosol. We have recently developed and validated methods to measure agonist-evoked changes in extracellular and intracellular store Ca^{2+} concentrations ($[\text{Ca}^{2+}]_{\text{ext}}$ and $[\text{Ca}^{2+}]_{\text{st}}$, respectively) in platelet cell suspensions [3, 4], which can be utilized alongside the measurement of agonist-evoked changes in $[\text{Ca}^{2+}]_{\text{cyt}}$ to improve the interpretation of results compared with simple cytosolic Ca^{2+} measurements alone. This methodology has been successfully used to demonstrate how the $\text{Na}^+/\text{Ca}^{2+}$ exchanger acts to create a pericellular source for Ca^{2+} recycling into the platelet, as well as allowing estimation of the Ca^{2+} buffering capacity of the platelet cytosol [3].

The study of Ca^{2+} signalling is complicated by the presence of Ca^{2+} feedback pathways, in which Ca^{2+} -sensitive signalling proteins can simultaneously modulate the activity of a number of Ca^{2+} translocating proteins during the course of Ca^{2+} signals. In human platelets, previous work has demonstrated a significant role for Protein Kinase C (PKC) in negatively regulating agonist-evoked Ca^{2+} signalling [e.g. 5]. However these kinases have a large variety of different molecular targets in platelets that could mediate the effect of this kinase on platelet Ca^{2+} signalling, with a number of publications suggesting a variety of mechanisms including inhibition of phospholipase C [6, 7], stimulation of inositol-1,4,5-trisphosphate (IP_3) breakdown [8, 9], stimulation of the plasma membrane Ca^{2+} -ATPase (PMCA) [10, 11], stimulation of sarco/endoplasmic reticulum Ca^{2+} -ATPases (SERCAs) [12] and in the case of ADP, desensitization of the receptor [13]. Since inhibition of PMCAs does not abolish the potentiatory effect of PKC inhibitors on thrombin-evoked Ca^{2+} rises, PMCAs do not appear to be involved in the response [14]. However, there is currently no consensus as to which of the other above target(s) may be principally responsible for the observed effects of PKC on agonist-evoked Ca^{2+} signalling.

ADP activates human platelets via actions on two receptors. The P2Y_1 receptor couples via G_q to phospholipase C- β (PLC- β) leading to the formation of IP_3 , which releases Ca^{2+} from the dense tubular system (DTS) [15, 16]. The P2Y_{12} receptor (formerly known as P2_T or P2_{AC}) couples via G_i to adenylyl cyclase [17] and phosphoinositide 3-kinase [18]. Thrombin activates human platelets via the protease-activated receptors (PARs) 1 and 4 [19]. PAR-1 and PAR-4 couple via G_q to PLC- β resulting in Ca^{2+} release from the DTS via IP_3 formation.

In addition, thrombin releases Ca^{2+} from acidic organelles via the formation of nicotinic acid adenine dinucleotide phosphate (NAADP) [4, 20].

Here we have examined the role of PKC in ADP- and thrombin-evoked Ca^{2+} signalling in human platelets utilizing a more comprehensive analysis of Ca^{2+} flux around the platelet than hitherto in an attempt to better identify the major molecular targets through which PKC regulates platelet Ca^{2+} signalling. We provide evidence that SERCA appears to be a common target of PKC during ADP- and thrombin-evoked Ca^{2+} signalling in human platelets and that the Na^+/K^+ -ATPase may act as a secondary PKC target when platelets are stimulated with the stronger platelet activator thrombin.

2. Materials and Methods

2.1. Materials

SBFI/AM and Fura-2/AM were from Texas Fluorescence Laboratories (Austin, TX, USA). PKC θ/δ inhibitor was from Merck Millipore (Nottingham, UK). Fluo-5N/AM and Fluo-4 K^+ salt were from Invitrogen Ltd (Paisley, UK). Bisindolylmaleimide I (Bisindo I) and BCECF/AM were from Tocris Bioscience (Bristol, UK). Gö6976 was from Abcam (Cambridge, UK). ADP, apyrase, digoxin, Ro-31-8220, thapsigargin, thrombin and 2,5-di(tert-butyl) 1,4-benzohydroquinone (TBHQ) were from Sigma-Aldrich (Gillingham, UK). All other reagents were of analytical grade.

2.2. Platelet preparation

Blood was collected under written informed consent by venepuncture from healthy drug-free volunteers with local ethical committee approval. The experiments conformed to the guidelines stated in the Declaration of Helsinki. Platelet-rich plasma prepared as previously described [20].

2.3. Cytosolic Ca^{2+} measurement

PRP was incubated with 2 μM Fura-2/AM for 45 min at 37 °C. Platelets were collected by centrifugation at $350 \times g$ for 20 min and resuspended in HEPES-buffered saline (HBS; 145 mM NaCl, 10 mM HEPES (N-2-hydroxyethylpiperazine-N'-2-ethanesulfonic acid), 10 mM D-glucose, 5 mM KCl, 1 mM MgSO_4 , pH 7.45) supplemented with 0.1% w/v BSA, 200 μM CaCl_2 and 40 $\mu\text{g ml}^{-1}$ apyrase (supplemented HBS). Fluorescence was recorded from 1 ml stirred aliquots of platelet suspension at 37 °C using a Cairn Research Spectrophotometer (Cairn Research, Faversham, UK) with excitation at 340 and 380 nm and emission at 500 nm. Changes in $[\text{Ca}^{2+}]_{\text{cyt}}$ were monitored using the 340/380 nm fluorescence ratio and calibrated according to the method of Grynkiewicz *et al.* [21].

2.4. Measurement of Ca^{2+} release into the extracellular medium

2.5 μM Fluo-4 K^+ salt was added to washed platelets suspended in supplemented HBS immediately prior to the start of the experiments. Fluo-4 fluorescence was recorded with excitation at 480 nm and emission at 515 nm, and calibrated as previously described [3]. A validation and quantitative analysis of this technique is presented in [3]. Ro-31-8220 and

BisIndo I have fluorescent properties at these wavelengths which could be overcome by performing calibration experiments in the presence and absence of Ro-31-8220 and BisIndo I.

2.5. Measurement of intracellular store Ca^{2+} concentration ($[Ca^{2+}]_{st}$)

The use of Fluo-5N-loaded platelets to measure $[Ca^{2+}]_{st}$ has previously been described [4]. PRP was incubated with 250 nM Fluo-5N/AM for 2 h at 37 °C. Cells were then collected by centrifugation at $350 \times g$ for 20 min and resuspended in supplemented HBS to which 100 μ M RGDS was added. RGDS peptide was included in all experiments to prevent aggregation and therefore artefactual decreases in Fluo-5N fluorescence. RGDS at this concentration has previously been demonstrated not to affect $[Ca^{2+}]_{cyt}$ signals in human platelets [22]. It was not possible to calibrate Fluo-5N measurements made in the presence of PKC inhibitors, as there were differential fluorescence effects of these drugs at the maximal and minimal fluorescences of Fluo-5N. However, it was possible to compensate for this autofluorescence to enable comparison of raw fluorescence values by correcting these values by subtracting the increase in fluorescence observed after addition of PKC inhibitors to the media at the end of F_{min} measurements as previously described [4].

2.6. Cytosolic Na^+ ($[Na^+]_{cyt}$) measurement

SBFI-loaded platelets were prepared as described previously [23]. SBFI fluorescence measurements were made as for Fura-2 above. Changes in $[Na^+]_i$ were monitored using the SBFI 340/380 nm fluorescence ratio.

2.7. Quantification of ADP- or thrombin-evoked changes in $[Ca^{2+}]_{cyt}$, $[Ca^{2+}]_{ext}$, and $[Na^+]_{cyt}$.

$[Ca^{2+}]_{cyt}$, $[Ca^{2+}]_{ext}$, and $[Na^+]_{cyt}$ were quantified by integration of the change in fluorescence records from basal with respect to time for 3 min after ADP or thrombin addition.

2.8. Statistical analysis

Values stated are mean \pm SEM of the number of observations (n) indicated. Analysis of statistical significance was performed either using a paired Student's t -test, or a repeated measures ANOVA followed by a post hoc Bonferroni multiple comparisons test. $P < 0.05$ was considered significant.

3. Results

3.1. PKC inhibitors potentiate ADP- and thrombin-evoked increases in $[Ca^{2+}]_{cyt}$ in the absence of extracellular Ca^{2+}

To keep this initial analysis as simple as possible, all experiments were performed in a Ca^{2+} free medium (1 mM EGTA was added to chelate extracellular Ca^{2+}) to prevent Ca^{2+} entry from contributing to agonist-evoked Ca^{2+} signals. As previously demonstrated by Strehl *et al.* [5], broad-spectrum PKC inhibitors potentiated the changes in platelet $[Ca^{2+}]_{cyt}$ evoked by ADP (50 μ M). Pretreatment of Fura-2-loaded human platelets for 10 minutes at 37°C with Ro-31-8220 (10 μ M) or BisIndo I (5 μ M) increased $[Ca^{2+}]_{cyt}$ signals to $226.9 \pm 9.1\%$ or $230.7 \pm 46.4\%$ of control respectively (Fig. 1A, B; both $n = 7$; $P < 0.05$). Similarly, the rises in $[Ca^{2+}]_{cyt}$ evoked by thrombin (0.5 units ml^{-1}) in the absence of extracellular Ca^{2+} were

increased by pretreatment for 10 minutes at 37°C with Ro-31-8220 (10 µM; Fig. 1C; 245.5 ± 6.1% of control; $n = 5$, $P < 0.05$) or BisIndo I (5 µM; Fig. 1D; 206.0 ± 5.8%; $n = 6$; $P < 0.05$).

ADP stimulation of platelets elicits Ca^{2+} signalling through the activation of the PLC-coupled $P2Y_1$ receptor, and is potentiated by activation of the $P2Y_{12}$ -mediated downregulation of adenylyl cyclase [21, 23]. Experiments were performed to examine whether $P2Y_{12}$ activity was a prerequisite for PKC-mediated inhibition of ADP-evoked Ca^{2+} signals. As shown in Fig. 1E and Fig. 1F, pretreatment of platelets with the $P2Y_{12}$ inhibitor, MeSAMP (75 µM), reduced ADP-evoked Ca^{2+} signals to 79.4 ± 5.0% of control ($n = 5$; $P < 0.05$), in agreement with previous findings [24]. Pretreatment of Fura-2-loaded platelets with 50 µM Ro-31-8220 was found to elicit the same potentiatory effect in both the presence (179.9 ± 24.0% of MeSAMP-treated control; $n = 5$; $P < 0.05$) and absence of MeSAMP (174.0 ± 16.1% of untreated control; $n = 5$; $P < 0.05$). These results demonstrate that the inhibitory effects of PKC on ADP-evoked Ca^{2+} signalling are mediated downstream of $P2Y_1$ - and not $P2Y_{12}$ -receptor stimulation in human platelets.

Previous work has demonstrated that the inhibitory effects of PKC on thrombin-evoked platelet Ca^{2+} signalling are elicited downstream of the activation of PAR1 but not PAR4 [14]. Since ADP can be released from dense granules upon platelet stimulation with thrombin, experiments were also performed to examine whether autocrine ADP stimulation plays a role in thrombin-evoked Ca^{2+} release. Pre-treatment of platelets with both MeSAMP (50 µM) and the $P2Y_1$ inhibitor, MRS-2179 (75 µM), elicited no significant inhibition of thrombin-evoked Ca^{2+} release (Fig. 1G; 92.8 ± 5.8% of control; $n = 6$; $P = 0.27$). In contrast, this combination of inhibitors significantly inhibited thrombin-evoked Ca^{2+} signals when platelets were stimulated in the presence of external Ca^{2+} (Fig. 1H; 76.7 ± 7.8% of control; $n = 6$; $P < 0.05$), demonstrating that the inhibitors were functional. These results demonstrate that autocrine ADP stimulation was not responsible for PKC-mediated inhibition of thrombin-evoked Ca^{2+} signals under the conditions used in this study.

3.2. PKC inhibitors potentiate ADP-evoked intracellular Ca^{2+} release and Ca^{2+} removal into the extracellular medium

We investigated whether the effects of the PKC inhibitors on ADP- or thrombin-evoked rises in $[Ca^{2+}]_{cyt}$ were due to an increase in the net rate of Ca^{2+} release from platelet intracellular Ca^{2+} stores [6-9, 12, 13] or a reduction in the rate of removal of Ca^{2+} into the extracellular medium [10, 11].

Pretreatment of Fluo-5N-loaded platelets with 10 µM Ro-31-8220 increased the ADP-evoked decrease in $[Ca^{2+}]_{st}$ to 242.1 ± 39.9% of control (Fig. 2A; $n = 8$; $P < 0.05$). ADP-evoked Ca^{2+} removal into the extracellular medium was enhanced after pretreatment with Ro-31-8220 or BisIndo I (209.6 ± 39.9% or 121.6 ± 8.0% of control respectively; Fig. 2B, C; both $n = 7$; $P < 0.05$). These data therefore suggest that the potentiation of ADP-evoked Ca^{2+} release was mediated via the potentiation of net Ca^{2+} release from intracellular stores, whilst the increase in Ca^{2+} removal was likely to be an indirect, compensatory response to the greater rise in $[Ca^{2+}]_{cyt}$.

3.3. SERCA inhibition abolishes the effect of PKC inhibitors on ADP- evoked changes in $[Ca^{2+}]_{cyt}$

Previous work has shown that treatment with phorbol esters, which stimulate PKC, increases Ca^{2+} sequestration in permeabilised platelets [25] and increases the V_{max} of SERCA [12].

Therefore we investigated whether the effects of PKC inhibitors on the ADP-evoked rise in $[Ca^{2+}]_{cyt}$ and fall in $[Ca^{2+}]_{st}$ might be due to a reduction in SERCA activity. This was done by examining the effects of concurrent inhibition of PKC and SERCAs (Fig. 3). Inhibition of SERCAs was achieved by treatment with a combination of both thapsigargin and TBHQ (TGT), to ensure that both the SERCA2b and SERCA3 isoforms present in human platelets were fully inhibited, as SERCA3 has previously been reported to be relatively insensitive to thapsigargin [26, 27]. Addition of SERCA inhibitors at the same time as ADP potentiated ADP-evoked rises in $[Ca^{2+}]_{cyt}$ ($529.0 \pm 97.2\%$ of control; $n = 5$; $P < 0.05$) as expected. In the presence of SERCA inhibitors, Ro-31-8220 had no significant additional effect on ADP-evoked rises in $[Ca^{2+}]_{cyt}$ (Fig. 3A; $108.1 \pm 4.6\%$ of SERCA-inhibited control; $n = 5$; $P > 0.1$). However, as expected, Ro-31-8220 still potentiated ADP-evoked rises in $[Ca^{2+}]_{cyt}$ in cells from the same preparations not treated with SERCA inhibitors (Fig. 3B; $209.1 \pm 14.5\%$ of control; $n = 5$; $P < 0.05$). These results suggest that PKC upregulates the activity of SERCAs during ADP-evoked Ca^{2+} signals, and that loss of this upregulation can account for the potentiation of ADP-evoked rises in $[Ca^{2+}]_{cyt}$ by PKC inhibitors.

3.4. PKC inhibitors inhibit thrombin-evoked intracellular Ca^{2+} release and Ca^{2+} removal into the extracellular medium

In platelets stimulated with the strong activator thrombin, PKC inhibition using BisIndo I reduced the net release of Ca^{2+} from the intracellular stores ($35.6 \pm 21.0\%$ of control; $n = 6$; $P < 0.05$; Fig 4A) as well as reducing the thrombin-evoked rise in $[Ca^{2+}]_{ext}$ ($22.0 \pm 4.3\%$ or $31.8 \pm 3.2\%$ of control for BisIndo I or Ro-81-3220 respectively; Fig. 4B, C; $n = 7$ or 6 ; both $P < 0.05$). These data suggests that the principal effect of PKC on thrombin-evoked Ca^{2+} signalling is inhibition of Ca^{2+} removal from the cytosol, whilst the reduced emptying of the intracellular stores is likely an indirect response to the greater rise in $[Ca^{2+}]_{cyt}$ (either by affecting the electrochemical gradient for Ca^{2+} release and/or providing a greater supply of Ca^{2+} to sequestration mechanisms such as SERCA).

3.5. PKC inhibitors potentiate thrombin-evoked changes in $[Na^+]_{cyt}$

The data presented above suggested that the principal action of PKC in thrombin-stimulated platelets was to inhibit Ca^{2+} removal across the plasma membrane. This Ca^{2+} flux is mediated by both the PMCA and NCX in human platelets [28, 29], with the PMCA providing a high affinity, low capacity system and the NCX a low affinity, high capacity system. Thrombin evokes substantial rises in $[Na^+]_{cyt}$ from around 5 mM to over 27 mM [30], which would be expected to influence NCX activity. We therefore investigated the effects of PKC inhibitors on thrombin-evoked changes in $[Na^+]_{cyt}$ in SBFI-loaded platelets to examine whether there was reduced Na^+ flux into the cytosol which might be due to reduced NCX activity. Surprisingly, pretreatment with BisIndo I (Fig. 5A) or Ro-81-3220 (Fig. 5B) potentiated the thrombin-evoked rises in $[Na^+]_{cyt}$ to $274.3 \pm 9.8\%$ or $287.2 \pm 19.8\%$ of control respectively (both $n = 6$, $P < 0.05$). Therefore we considered whether the greater rise in $[Na^+]_{cyt}$ might be responsible for the reduced Ca^{2+} removal into the extracellular medium observed in the previous Fluo-4 experiments, by slowing forward mode Na^+/Ca^{2+} exchange.

3.6. PKC inhibitors are without effect on thrombin-evoked rises in $[Ca^{2+}]_{cyt}$ following SERCA inhibition and removal of extracellular Na^+

To examine whether greater thrombin-evoked rises in $[Na^+]_{cyt}$ were responsible for the effect of the PKC inhibitors on $[Ca^{2+}]_{cyt}$, experiments were conducted in which extracellular Na^+ was substituted with the cell-impermeant cation *N*-methyl-D-glucamine (NMDG). In

addition, we examined the effect of concurrent inhibition of SERCA, to see whether the upregulation of SERCA by PKC might also contribute to its effects on the thrombin-evoked response as it does with ADP. As previously observed, pretreatment of control cells with Ro-81-3220 potentiated the thrombin-evoked rise in $[Ca^{2+}]_{cyt}$ ($222.5 \pm 13.2\%$ of control; $n = 6$, $P < 0.05$; Fig. 6A). Replacing extracellular Na^+ with NMDG reduced but did not abolish the Ro-81-3220-mediated potentiation of the thrombin evoked rise in $[Ca^{2+}]_{cyt}$ ($163.9 \pm 8.5\%$ of control; $n = 6$, $P < 0.05$; Fig. 6B). Similarly inhibition of SERCA failed to prevent the potentiating effect of Ro-81-3220 on $[Ca^{2+}]_{cyt}$ in thrombin-stimulated platelets ($127.0 \pm 1.9\%$ of control; $n = 6$, $P < 0.05$; Fig. 6C). However, following SERCA inhibition in combination with removal of extracellular Na^+ , pretreatment with Ro 81-3220 was without effect on the thrombin evoked rise in $[Ca^{2+}]_{cyt}$ ($102.3 \pm 2.4\%$ of control, ($n = 6$, $P > 0.05$; fig. 6D).

This result suggests that PKC activity limits thrombin-evoked rises in $[Ca^{2+}]_{cyt}$ by two different actions. Firstly PKC activity increases SERCA activity, promoting the uptake of Ca^{2+} into intracellular stores. Secondly, PKC activity reduces the thrombin-evoked rise in $[Na^+]_{cyt}$, so reducing inhibition of forward mode Na^+/Ca^+ exchange.

3.7. PKC inhibitors have no effect on the thrombin-evoked opening of non-selective cation channels.

To examine whether the effect of PKC inhibitors on thrombin-evoked rises in $[Na^+]_{cyt}$ was due to an enhanced permeability of the platelet plasma membrane to cations, we examined whether PKC inhibitors altered the thrombin-evoked increase in divalent cation entry utilizing Mn^{2+} quench of Fura-2 fluorescence [31]. Pre-incubating platelets with the PKC inhibitors BisIndo I or Ro 81-3220, had no discernible effect on the thrombin evoked Mn^{2+} quench (Fig. 7), which was $100.2 \pm 3.7\%$ of control ($n = 6$, $p > 0.05$) after treatment with BisIndo I ($5 \mu M$; Fig 7A) and $97.3 \pm 2.7\%$ of control ($n=6$, $p > 0.05$; Fig 7B) after treatment with Ro 81-3220 ($10 \mu M$). These data demonstrate that PKC is not mediating its inhibitory effects on platelet Ca^{2+} signalling via inhibition of plasma membrane non-selective cation channels.

3.8. PKC inhibitors are without effect on thrombin-evoked rises in $[Ca^{2+}]_{cyt}$ following SERCA and Na^+/K^+ -ATPase inhibition

As cation channel opening is not affected and Ca^{2+} removal across the plasma membrane (presumably via the NCX) is inhibited when platelets are preincubated with PKC inhibitors, these data suggested that the greater thrombin-evoked rise in $[Na^+]_{cyt}$ might be mediated by blockade of a PKC-mediated upregulation of Na^+/K^+ -ATPase activity. To test this hypothesis, we investigated whether removing extracellular K^+ or pretreating cells with Na^+/K^+ -ATPase inhibitor digoxin could reverse the effect of PKC inhibitors on $[Ca^{2+}]_{cyt}$ when cells were concurrently treated with SERCA inhibitors.

To physiologically inhibit the Na^+/K^+ -ATPase, extracellular K^+ was replaced with Na^+ . In these platelet preparations under control conditions (K^+ -containing medium), pretreatment with Ro 81-3220 potentiated thrombin-evoked rises in $[Ca^{2+}]_{cyt}$ to $183.0 \pm 3.7\%$ of control (Fig. 8A; $n = 9$, $P < 0.05$) and pretreatment with SERCA inhibitors only partially reduced this potentiation to $128.4 \pm 4.7\%$ of control (Fig. 8B; $n = 9$, $P < 0.05$). In the absence of extracellular K^+ , Ro 81-3220 potentiated thrombin-evoked rises in $[Ca^{2+}]_{cyt}$ to $165.1 \pm 5.6\%$ of control (Fig. 8C; $n = 9$, $P < 0.05$). These results are as would be expected if both SERCA and Na^+/K^+ -ATPase activity were concurrently upregulated by PKC upon thrombin

stimulation. In contrast, when platelets were stimulated with thrombin in a K^+ -free medium and concurrently treated with SERCA inhibitors, there was no additional effect of Ro 81-3220 on thrombin-evoked rises in $[Ca^{2+}]_{cyt}$ ($98.3 \pm 3.2\%$ of the K^+ -free and SERCA – inhibited control; Fig. 8D; $n = 9$; $P > 0.5$), suggesting that the Na^+/K^+ -ATPase was responsible for mediating the additional effect of PKC on thrombin-stimulated platelets after SERCA inhibition.

To confirm this finding we pharmacologically inhibited the Na^+/K^+ -ATPase, by pretreating platelets with digoxin ($100 \mu M$) for 1 h at $37^\circ C$. Following prolonged incubation at $37^\circ C$, thrombin-evoked responses were smaller and records more noisy than those observed in earlier experiments, probably due to the leak of Fura-2 from the platelets. Under these conditions, Ro 81-3220 again potentiated thrombin-evoked rises in $[Ca^{2+}]_{cyt}$ in untreated cells to $167.0 \pm 10.1\%$ of control (Fig. 9A; $n = 6$, $P < 0.05$). Pretreatment with SERCA inhibitors reduced this potentiation to $119.6 \pm 4.9\%$ of SERCA –inhibited control (Fig. 9B; $n = 6$, $P < 0.05$) and pretreatment with digoxin reduced it to $146.8 \pm 8.6\%$ of control (Fig. 9C; $n = 6$, $P < 0.05$). However treatment with both SERCA inhibitors and digoxin abolished the potentiation of the thrombin-evoked rise in $[Ca^{2+}]_{cyt}$ by Ro 81-3220 (Fig. 9D; $105.0 \pm 3.2\%$ of SERCA and digoxin-treated control, $n = 6$, $P > 0.5$). This result suggests that the influence of PKC on thrombin-evoked rises in $[Ca^{2+}]_{cyt}$ results from combined increased activity of the Na^+/K^+ -ATPase and SERCAs.

3.9 Conventional PKC isoforms mediate inhibitory effects on both ADP- and thrombin-evoked Ca^{2+} signalling

The data presented above using broad-spectrum PKC inhibitors suggest at least two distinct roles for this kinase in regulating platelet Ca^{2+} signalling. However, since human platelets possess a number of PKC isoforms [25], there is a possibility that the PKC-dependent effects on Na^+/K^+ -ATPase and SERCA activities may be mediated by distinct PKC isoforms. Therefore experiments were conducted to examine which isoforms of PKC might be involved in mediating these inhibitory effects on platelet Ca^{2+} signalling. Human platelets are known to express both the conventional PKC α and PKC β isoforms, and the novel PKC isoforms, PKC δ and PKC θ [25]. These subgroups of PKC isoforms can be differentiated by the response to rises in intracellular Ca^{2+} concentration, with the classical isoforms being regulated by Ca^{2+} and diacylglycerol binding, whilst the novel isoforms require only diacylglycerol to increase their kinase activity [32]. Experiments were therefore performed to examine the effects on agonist-evoked Ca^{2+} signalling of compounds able to differentially inhibit the classical isoforms (Gö6976) and novel isoforms (PKC θ/δ inhibitor) expressed in human platelets. Previous work has demonstrated that Gö6976 can also inhibit the tyrosine kinase, Syk, in platelets [33]. However previous work has shown that the tyrosine kinase inhibitor, Genistein which has been shown to inhibit agonist-evoked Syk activation in human platelets [34], has no effect on thrombin- or ADP-evoked Ca^{2+} release [35, 36]. In addition, a recent report using a specific Syk inhibitor, PRT-060318, found no effect on TRAP-induced Ca^{2+} signals at concentrations found to inhibit over 90% of the convulxin-induced Ca^{2+} response [37]. These results therefore suggest that any effect of Gö6976 observed on platelet Ca^{2+} signalling is limited to its effect on conventional PKC isoforms.

Firstly, we examined the effect of the conventional PKC inhibitor, Gö6976, on thrombin- and ADP-evoked Ca^{2+} release. As shown in Figures 10A and 10C, pretreatment with Gö6976 ($3 \mu M$) potentiated both ADP- ($167.5 \pm 22.5\%$ of control; $n = 5$, $P < 0.05$) and thrombin-evoked ($174.3 \pm 9.8\%$ of control; $n = 6$, $P < 0.05$) Ca^{2+} signals. Similar to our above findings

with broad-spectrum PKC inhibitors, the effect of Gö6976 on ADP-evoked Ca^{2+} signalling was abolished by the addition of SERCA inhibitors concomitantly with ADP stimulation (101.3 ± 4.2 % of control; Fig.10B; $n = 5$, $P > 0.05$). In contrast, the effect of Gö6976 on thrombin-evoked Ca^{2+} signalling was found to only be partially reduced by either inhibition of SERCAs (126.4 ± 3.0 % of control; Fig. 10D; $n = 6$, $P < 0.05$), or replacement of extracellular Na^+ with NMDG (153.6 ± 6.3 % of control; Fig. 10E; $n = 6$, $P < 0.05$). However, the combination of both of these treatments was found to abolish the effect of Gö6976 on thrombin-evoked Ca^{2+} signalling ($102. \pm 22.5$ % of control; Fig. 10F; $n = 6$, $P > 0.05$). These findings are in line with our above results using broad-spectrum PKC inhibitors, and suggest that conventional PKC isoforms are responsible for the inhibitory effects on both SERCAs and the Na^+/K^+ -ATPase.

PKC θ/δ inhibitor potently inhibits novel PKC isoforms with an IC_{50} of 70 nM for PKC θ , and 350 nM for PKC δ , with no notable effect on conventional PKC isoforms ($\text{IC}_{50} > 50$ μM for PKC β) [38]. Pretreatment of Fura-2-loaded human platelets with PKC θ/δ inhibitor was found not to potentiate ADP-evoked Ca^{2+} release at lower concentrations (100 or 300 nM; 102.9 ± 5.2 % or 91.4 ± 8.5 % of control; Fig 11A both $n = 6$ and $P > 0.05$) and to inhibit ADP-evoked Ca^{2+} release at higher concentration (1 or 3 μM ; $75.4 \pm 8.8\%$ or $53.9 \pm 14.5\%$ of control; both $n = 6$ and $P < 0.05$), suggesting that novel PKC isoforms are not responsible for activating SERCA and Na^+/K^+ -ATPase activity in ADP-stimulated platelets. Further experiments considered the possibility that the activities of novel and conventional PKC isoforms are redundant in modulating ADP- and thrombin-evoked Ca^{2+} release. Pretreatment of platelets with Gö6976 alone induced a significant potentiation of both ADP- (146.7 ± 11.3 % of control; $n = 6$; Fig 11B; $P < 0.05$) and thrombin-evoked Ca^{2+} signals (168.7 ± 13.3 % of control; $n = 5$; Fig 11C; $P < 0.05$). In contrast, pretreatment of platelets with PKC θ/δ inhibitor (300 nM) had no significant effect on the Ca^{2+} signals elicited by either agonist ($92.2 \pm 5.5\%$ or 98.5 ± 5.3 % of control for ADP and thrombin respectively; both $n = 6$ and 5; $P > 0.05$). When used in combination the effect of these two inhibitors was found to lead to a small but consistent reduction in the potentiation elicited by Gö6976 alone ($122.5 \pm 7.7\%$ or 151.2 ± 10.9 % of control for ADP and thrombin respectively; $n = 6$ and 5 respectively). These results therefore support our finding that conventional, but not novel, isoforms of PKC are involved in mediating the inhibitory effect of PKC on platelet Ca^{2+} signalling.

Discussion

In this study, we have adopted a more rigorous approach for examining Ca^{2+} signalling in platelets than simply monitoring $[\text{Ca}^{2+}]_{\text{cyt}}$. By monitoring the flux of Ca^{2+} to and from the Ca^{2+} sources and sinks which supply the cytosol, in addition to monitoring the $[\text{Ca}^{2+}]_{\text{cyt}}$ itself, we have been able to show that while PKC has a negative effect on Ca^{2+} signalling in ADP- and thrombin-stimulated platelets, the principal point of action on this signalling system is distinct for these agonists. Whilst the main effect of PKC on Ca^{2+} fluxes during ADP-evoked signalling appeared to be a reduction in net Ca^{2+} efflux from intracellular stores, the major mode of action of PKC in thrombin-stimulated platelets appeared to be in facilitating Ca^{2+} removal across the plasma membrane. These results highlight the need to look beyond merely examining the net effect of any experimental manipulation of the platelet signalling system on agonist-evoked rises in $[\text{Ca}^{2+}]_{\text{cyt}}$, to examine how these manipulations affect the flux of Ca^{2+} from or into the component Ca^{2+} sources and sinks. By doing this we have demonstrated an agonist-dependent signalling function of the PKC system in human platelets and have been better able to design further experiments to pinpoint the molecular pathways affected. This has allowed us to demonstrate that PKC upregulates SERCA activity in response to both

ADP and thrombin, but that Na⁺/K⁺-ATPase activity is also affected when the stronger platelet activator thrombin is used (Fig. 12). The reasons for this difference are currently unclear but may relate to the lower diacylglycerol concentrations observed in platelets stimulated with ADP compared with thrombin [39, 40]. The reduced translocation of PKC to the plasma membrane might limit the ability of PKC to significantly alter the activity of Na⁺/K⁺-ATPase in ADP-stimulated platelets [41, 42]. Future work examining the role of modulating diacylglycerol levels in ADP-stimulated platelets might help delineate this pathway further [39].

By studying the effects of PKC inhibitors that are able to selectively inhibit either the novel or conventional PKC isoforms expressed in human platelets, we have provided evidence that the negative regulation of ADP- and thrombin-evoked Ca²⁺ signalling is likely to be selectively mediated via conventional PKC isoforms. This is in line with previous data that demonstrated a role for PKCβ (but not PKCθ or PKCδ) in inhibiting ADP-evoked Ca²⁺ signals in human platelets [43]. In contrast, treating platelets with an inhibitor of novel PKC isoforms appears to suppress the Ca²⁺ signals elicited by ADP and thrombin. Interestingly, previous work has demonstrated that collagen-evoked Ca²⁺ signalling in human platelets is negatively regulated by novel PKC isoforms and positively regulated by conventional PKC isoforms [44]. An agonist-specific effect of isoform-selective PKC inhibition has also been reported for platelet dense granule secretion [45]. These results beg the question as to whether novel PKC isoforms are potentiating collagen-evoked signalling by triggering the same effects on SERCA and Na⁺/K⁺-ATPase activity elicited by the conventional isoforms upon thrombin- or ADP-stimulation, or whether there are distinct molecular targets for PKC that modulate collagen-evoked Ca²⁺ signals.

Whilst this approach to the study of Ca²⁺ signalling does provide a better foundation from which to explore molecular pathways, there are limitations in that it will only identify the net effect of the experimental manipulations on Ca²⁺ flux to or from intracellular stores and the extracellular space. This means that counteracting effects on these fluxes may not show up if they cancel themselves out. Thus it is important to note that this analysis only detects the principal effects on the Ca²⁺ signalling system, and we cannot rule out additional effects of PKC on the system.

In addition, whilst we have been able to identify SERCAs and the Na⁺/K⁺-ATPase as the final targets of PKC in this system, we have no ability to distinguish between the possibility that PKC directly regulates the activity of these transporters through phosphorylation, or indirectly through an intermediate signalling protein or binding partner. Thus at this stage we can only speculate on how the Na⁺/K⁺-ATPase and SERCAs are regulated by PKC.

Previous work has demonstrated that treatment with PKC-activating phorbol esters increases SERCA activity in permeabilised platelets [12]. Although SERCA activity has been reported to be increased by PKC activation in other cells [46], we believe our results provide the first evidence for the regulation of SERCA by PKC in intact platelets under the control of physiological agonists. It is possible that this regulation may be direct as phosphoproteomic profiling of platelets has previously shown a serine phosphorylation of SERCA2 [47]. However, Tao and colleagues [12] have previously suggested that PKC may affect SERCA indirectly via phosphorylation of Rap1b. Given that PKC has been shown to phosphorylate and activate Rap1b [48, 49] and that phosphorylation of Rap1b by other kinases is thought to regulate SERCA activity in platelets [50-52], Rap1b may be involved in the regulation of

SERCA activity by PKC. Further studies investigating the phosphorylation of SERCA and association of Rap1b with SERCA may help distinguish between these possibilities.

The molecular mechanism by which PKC influences Na⁺/K⁺-ATPase activity in platelets is less clear. PKC has been reported to increase Na⁺/K⁺-ATPase activity in other cell types including arterial smooth muscle [53] and cardiac myocytes [54]. However, unlike with SERCA, there is no evidence for phosphorylation of this protein in the resting platelet phosphoproteome [47], although given the need for activation with a strong platelet activator for the Na⁺/K⁺-ATPase to be influenced by PKC, phosphorylation of this protein might not be expected under resting conditions. In cardiac muscle and several other cell types, Na⁺/K⁺-ATPase activity is modulated by association with members of the FXYD family of proteins [55]. However, no members of the FXYD family have been detected in the platelet proteome [56]. Another possibility is that there is a change in surface expression of the Na⁺/K⁺-ATPase in thrombin-stimulated platelets. Surface expression of this transporter has been reported to increase more than ten-fold in ADP stimulated platelets as assessed by [³H]-ouabain binding [57]. Given the central role of PKC in granule secretion in platelets [32], it is not inconceivable that thrombin-evoked activation of PKC may also increase the apparent activity of Na⁺/K⁺-ATPase through modulation of its expression in the platelet plasma membrane.

Acknowledgements

This work was funded by the British Heart Foundation (PG/07/100/23759). AGSH was supported by a Research Fellowship from St Catharine's College, University of Cambridge. RAL was supported by a Wellcome Trust Summer Studentship and BBS by a Browning Summer Bursary from Magdalene College, Cambridge. We thank Alexander D.A. Thompson for assistance with experiments involving isoform-selective PKC inhibitors.

Figure legends

Fig. 1. PKC inhibitors potentiate ADP- and thrombin-evoked increases in [Ca²⁺]_{cyt}. Fura-2-loaded human platelets were suspended in supplemented HBS containing 200 μM CaCl₂, and preincubated with either 10 μM Ro-31-8220 (A,C, E, F), 5 μM BisIndo I (B, D), 75 μM MeSAMP (F), 75 μM MesAMP and 75 μM MRS-2179 (G,H) or their vehicle, DMSO as indicated, for 10 min at 37°C. Extracellular Ca²⁺ was then chelated by addition of 1 mM EGTA (A-G) or extracellular Ca²⁺ was raised to 1 mM by addition of 800 μM CaCl₂ (H) before the platelets were stimulated with 50 μM ADP (A, B, E, F) or 0.5 units ml⁻¹ thrombin (C, D, G, H).

Fig. 2. PKC inhibitors potentiate ADP-evoked intracellular Ca²⁺ release and Ca²⁺ removal into the extracellular medium. A. Fluo-5N –loaded human platelets were suspended in supplemented HBS containing 200 μM CaCl₂ and preincubated with 10 μM Ro-31-8220 or the vehicle, DMSO, for 10 min at 37°C. Extracellular Ca²⁺ was then chelated by addition of 1 mM EGTA before the platelets were stimulated with 50 μM ADP. B, C. Washed human platelets were suspended in a supplemented HBS containing 200 μM CaCl₂, and preincubated with either 10 μM Ro-31-8220 (B), 5 μM BisIndo I (C) or their vehicle, DMSO, for 10 min

at 37°C. 2.5 μM Fluo-4 K^+ salt was then added immediately prior to the start of the experiments. Extracellular Ca^{2+} was chelated by addition of 1 mM EGTA and the platelets were then stimulated with 50 μM ADP.

Fig. 3. SERCA inhibition abolishes the effect of PKC inhibitors on ADP- evoked changes in $[\text{Ca}^{2+}]_{\text{cyt}}$. Fura-2-loaded human platelets were suspended in supplemented HBS containing 200 μM CaCl_2 and preincubated with 10 μM Ro-31-8220 or its vehicle, DMSO, for 10 minutes at 37°C. Extracellular Ca^{2+} was then chelated by addition of 1 mM EGTA and the platelets stimulated with 50 μM ADP and either both SERCA inhibitors, 1 μM thapsigargin and 20 μM TBHQ (TGT), or an equal volume of their vehicle, DMSO.

Fig. 4. PKC inhibitors inhibit thrombin-evoked intracellular Ca^{2+} release and Ca^{2+} removal into the extracellular medium. A. Fluo-5N-loaded human platelets were suspended in supplemented HBS containing 200 μM CaCl_2 and preincubated with 10 μM Ro-31-8220 or the vehicle, DMSO, for 10 min at 37°C. Extracellular Ca^{2+} was then chelated by addition of 1 mM EGTA before the platelets were stimulated with 0.5 units ml^{-1} thrombin. B, C. Washed human platelets were suspended in a supplemented HBS containing 200 μM CaCl_2 , and preincubated with either 10 μM Ro-31-8220 (B), 5 μM BisIndo I (C) or their vehicle, DMSO, for 10 min at 37°C. 2.5 μM Fluo-4 K^+ salt was then added immediately prior to the start of the experiments. Extracellular Ca^{2+} was chelated by addition of 1 mM EGTA and the platelets were then stimulated with 0.5 units ml^{-1} thrombin.

Fig. 5. PKC inhibitors potentiate thrombin-evoked changes in $[\text{Na}^+]_{\text{cyt}}$. SBFI-loaded human platelets were suspended in supplemented HBS containing 200 μM CaCl_2 and preincubated with either 5 μM BisIndo I (A), 10 μM Ro-31-8220 (B) or their vehicle, DMSO, for 10 min at 37°C. Extracellular Ca^{2+} was then chelated by addition of 1 mM EGTA and the platelets were then stimulated with 0.5 units ml^{-1} thrombin.

Fig. 6. PKC inhibitors are without effect on thrombin-evoked rises in $[\text{Ca}^{2+}]_{\text{cyt}}$ following SERCA inhibition and removal of extracellular Na^+ . Fura-2-loaded human platelets were suspended in supplemented HBS (A, C) or a similar medium in which Na^+ was replaced with NMDG (B, D) containing 200 μM CaCl_2 and preincubated with 10 μM Ro-31-8220 or its vehicle, DMSO, for 10 min at 37°C. Extracellular Ca^{2+} was then chelated by addition of 1 mM EGTA and the platelets stimulated with 0.5 units ml^{-1} thrombin and either both 1 μM thapsigargin and 20 μM TBHQ (TGT), or an equal volume of their vehicle, DMSO.

Fig. 7. PKC inhibitors have no effect on the thrombin-evoked opening of non-selective cation channels. Fura-2-loaded human platelets were suspended in a Ca^{2+} -free medium, and preincubated with either 5 μM BisIndo I (A), 10 μM Ro-31-8220 (B) or their vehicle, DMSO (A,B), for 10 min at 37°C. 500 μM EGTA was then added followed by the addition of 1 mM MnCl_2 . Platelets were then stimulated with 0.5 units ml^{-1} thrombin. An unstimulated control sample is also shown in both panels

Fig. 8. PKC inhibitors are without effect on thrombin-evoked rises in $[\text{Ca}^{2+}]_{\text{cyt}}$ following SERCA and Na^+/K^+ -ATPase inhibition by removal of extracellular K^+ . Fura-2-loaded human platelets were suspended in supplemented HBS (A, C) or a similar medium in which K^+ was replaced with Na^+ (B, D) containing 200 μM CaCl_2 and preincubated with 10 μM Ro-31-8220 or its vehicle, DMSO, for 10 min at 37°C. Extracellular Ca^{2+} was then chelated by addition of 1 mM EGTA and the platelets stimulated with 0.5 units ml^{-1} thrombin and either both 1 μM thapsigargin and 20 μM TBHQ (TGT), or an equal volume of their vehicle, DMSO.

Fig. 9. PKC inhibitors are without effect on thrombin-evoked rises in $[Ca^{2+}]_{cyt}$ following SERCA and Na^+/K^+ -ATPase inhibition using digoxin. Fura-2-loaded human platelets were suspended in supplemented HBS containing 200 μ M $CaCl_2$ and preincubated with 100 μ M digoxin (C, D) or its vehicle, DMSO (A, B), for 1 h at 37°C and 10 μ M Ro-31-8220 or its vehicle, DMSO, for 10 min at 37°C. Extracellular Ca^{2+} was then chelated by addition of 1 mM EGTA and the platelets stimulated with 0.5 units ml^{-1} thrombin and either both 1 μ M thapsigargin and 20 μ M TBHQ (TGT; B, D), or an equal volume of their vehicle, DMSO (A, C).

Fig. 10. The conventional PKC isoform inhibitor Gö6976 potentiates ADP- and thrombin-evoked rises in $[Ca^{2+}]_{cyt}$. Fura-2-loaded human platelets were suspended in supplemented HBS (A-D) or a similar medium in which Na^+ was replaced with NMDG (E, F) containing 200 μ M $CaCl_2$ and preincubated with 3 μ M Gö6976 or its vehicle, DMSO, for 10 min at 37°C. Extracellular Ca^{2+} was then chelated by addition of 1 mM EGTA and the platelets stimulated with 50 μ M ADP (A, B) or 0.5 units ml^{-1} thrombin (C-F) and either both 1 μ M thapsigargin and 20 μ M TBHQ (TGT; B, D, F), or an equal volume of their vehicle, DMSO (A, C, E).

Fig. 11. The novel PKC isoform (PKC θ/δ inhibitor) does not potentiate ADP- or thrombin-evoked rises in $[Ca^{2+}]_{cyt}$. (A) Fura-2-loaded human platelets were suspended in supplemented HBS containing 200 μ M $CaCl_2$, and preincubated with 100 nM, 300 nM, 1 μ M or 3 μ M PKC θ/δ inhibitor or its vehicle, DMSO, for 10 min at 37°C. Extracellular Ca^{2+} was then chelated by addition of 1 mM EGTA before the platelets were stimulated with 50 μ M ADP. (B, C) Fura-2-loaded human platelets were suspended in supplemented HBS containing 200 μ M $CaCl_2$, and preincubated with 300 nM PKC θ/δ inhibitor, 3 μ M Gö6976, both inhibitors or their vehicle, DMSO, for 10 min at 37°C. Extracellular Ca^{2+} was then chelated by addition of 1 mM EGTA before the platelets were stimulated with 50 μ M ADP (B) or 0.5 units ml^{-1} thrombin. Results are expressed as mean of percentage control responses. * = $P < 0.05$ v. control, † = $P < 0.05$.

Fig. 12. Model for proposed effects of PKC in controlling ADP- and thrombin-evoked Ca^{2+} signalling in human platelets. The agonist-evoked rise in $[Ca^{2+}]_{cyt}$ is controlled by the conventional protein kinase C isoforms, PKC α and PKC β , by altering the rate of Ca^{2+} removal into the extracellular fluid and Ca^{2+} sequestration into intracellular stores in an agonist-dependent manner. Upon ADP activation, PKC negatively regulates the Ca^{2+} signal by increasing Ca^{2+} sequestration back into the dense tubular system through activation of SERCA. Upon thrombin stimulation, PKC additionally regulates Ca^{2+} removal from the cytosol into the extracellular space by increasing the activity of the Na^+/K^+ -ATPase. This in turn limits agonist-evoked rises in $[Na^+]_{cyt}$, which slows Ca^{2+} efflux via forward mode Na^+/Ca^{2+} exchange.

References

1. A.G.S. Harper, M.J. Mason, S.O. Sage, A key role for dense granule secretion in potentiation of the Ca^{2+} signal arising from store-operated calcium entry in human platelets, *Cell Calcium*. 45 (2009) 413-420.
2. M.T. Harper, M.J. Mason, S.O. Sage, A.G.S. Harper, Phorbol ester-evoked Ca^{2+} signaling in human platelets is via autocrine activation of P_{2X_1} receptors, not a novel non-capacitative Ca^{2+} entry. *J Thromb Haemost*. 8 (2010) 1604-1613.
3. S.O. Sage, N. Pugh, R.W. Farndale, A.G.S. Harper, Pericellular Ca^{2+} recycling potentiates thrombin-evoked Ca^{2+} signals in human platelets, *Physiological Reports*. 1 (2013) e00085.
4. S.O. Sage, N. Pugh, M.J. Mason, A.G.S. Harper, Monitoring the intracellular store Ca^{2+} concentration in agonist-stimulated, intact human platelets using Fluo-5N, *J Thromb Haemost*. 9 (2011) 540-551.
5. A. Strehl, I.C. Munnix, M.J. Kuijpers, P.E. van der Meijden, J.M. Cosemans, M.A. Feijge, B. Nieswandt, J.W. Heemskerk, Dual role of platelet protein kinase C in thrombus formation: stimulation of pro-aggregatory and suppression of procoagulant activity in platelets, *J Biol Chem*. 282 (2007) 7046-7055.
6. S.E. Rittenhouse, J.P. Sasson, Mass changes in myoinositol trisphosphate in human platelets stimulated by thrombin. Inhibitory effects of phorbol ester, *J Biol Chem*. 260 (1985) 8657-60.
7. G.B. Zavoico, S.P. Halenda, R.I. Sha'afi, M.B. Feinstein, Phorbol myristate acetate inhibits thrombin-stimulated Ca^{2+} mobilization and phosphatidylinositol 4,5-bisphosphate hydrolysis in human platelets, *Proc Natl Acad Sci U S A*. 82 (1985) 3859-3862.
8. W.G. King, S.E. Rittenhouse, Inhibition of protein kinase C by staurosporine promotes elevated accumulations of inositol trisphosphates and tetrakisphosphate in human platelets exposed to thrombin, *J Biol Chem*. 264 (1989) 6070-6074.
9. T.M. Connolly, W.J. Lawing Jr, P.W. Majerus, Protein kinase C phosphorylates human platelet inositol trisphosphate 5'-phosphomonoesterase, increasing the phosphatase activity *Cell*. 46 (1986) 951-958.
10. L. Cavallini, A. Alexandre, Ca^{2+} efflux from platelets. Control by protein kinase C and the filling state of intracellular stores, *Eur J Biochem*. 222 (1994) 693 -702.
11. W.K. Pollock, S.O. Sage, T.J. Rink, Stimulation of Ca^{2+} efflux from fura-2-loaded platelets activated by thrombin or phorbol myristate acetate, *FEBS Lett*. 210 (1987) 132-136.
12. J. Tao, J.S. Johansson, D.H. Haynes, Protein Kinase C regulates dense tubular Ca^{2+} uptake in the intact human platelet by increasing V_m of the Ca^{2+} -ATPase pump: stimulation by phorbol ester, inhibition by calphostin C, *Biochim Biophys Acta*. 1107 (1992) 213-222

13. A.R. Hardy, P.B. Conley, J. Luo, J.L. Benovic, A.W. Poole, S.J. Mundell, P2Y₁ and P2Y₁₂ receptors for ADP desensitize by distinct kinase-dependent mechanisms, *Blood*. 105 (2005) 3552-3560.
14. M.T. Harper, A.W. Poole, PKC inhibition markedly enhances Ca²⁺ signaling and phosphatidylserine exposure downstream of protease-activated receptor-1 but not protease-activated receptor-4 in human platelets, *J Thromb Haemost.* 9 (2011) 1599-1607.
15. C. Léon, B. Hechler, M. Freund, A. Eckly, C. Vial, P. Ohlmann, A. Dierich, M. LeMeur, J.P. Cazenave, C. Gachet, Defective platelet aggregation and increased resistance to thrombosis in purinergic P2Y₁ receptor-null mice, *J Clin Invest.* 104 (1999) 1731–1737.
16. L.F. Brass, S.K. Joseph, A role for inositol trisphosphate in intracellular Ca²⁺ mobilisation and granule secretion in platelets, *J Biol Chem.* 260 (1985) 15172-15179.
17. J.L. Daniel, C. Dangelmaier, J. Jin, B. Ashby, J.B. Smith, S.P. Kunapuli, Molecular basis for ADP-induced platelet activation. I. Evidence for three distinct ADP receptors on human platelets, *J Biol Chem.* 273 (4) (Jan 23 1998) 2024–2029.
18. C. Dangelmaier, J. Jin, J.B. Smith, S.P. Kunapuli, Potentiation of thromboxane A₂-induced platelet secretion by G_i signaling through the phosphoinositide-3 kinase pathway, *Thromb Haemost.* 85 (2001), pp. 341–348.
19. M.L. Kahn, M. Nakanishi-Matsui, M.J. Shapiro, H. Ishihara, S.R. Coughlin, Protease-activated receptors 1 and 4 mediate activation of human platelets by thrombin, *J Clin Invest* 103 (1999) 879-887.
20. S.L. Brownlow, S.O. Sage, Transient receptor potential protein subunit assembly and membrane distribution in human platelets, *Thromb Haemost* 94 (2005) 839-845.
21. G. Grynkiewicz, M. Poenie, R.Y. Tsien, A new generation of Ca²⁺ indicators with greatly improved fluorescence properties, *J Biol Chem.* 260 (1985) 3440–3450.
22. J.A. Rosado, E.M. Meijer, K. Hamulyak, I. Novakova, J.W. Heemskerk, S.O. Sage, Fibrinogen binding to the integrin alpha(IIb)beta(3) modulates store-mediated calcium entry in human platelets, *Blood* 97 (2001) 2648-2656.
23. A.G.S. Harper, S.O. Sage, A key role for reverse Na⁺/Ca²⁺ exchange influenced by the actin cytoskeleton in store-operated Ca²⁺ entry in human platelets: evidence against the de novo conformational coupling hypothesis, *Cell Calcium.* 42 (2007) 606-617.
24. S.O. Sage, E.H. Yamoah, J.W.M. Heemskerk, The role of P(2X₁) and P(2T AC) receptors in ADP-evoked calcium signalling in human platelets, *Cell Calcium* 28 (2000) 119-126.
25. K. Yoshida, V.T. Nachmias, Phorbol ester stimulates Ca²⁺ sequestration in saponised human platelets, *J Biol Chem.* 262 (1987) 16048-16054.

26. A. Enyedi, B. Sarkadi, Z. Foldes-Papp, S. Monostory, G. Gárdos, Demonstration of two distinct calcium pumps in human platelet membrane vesicles, *J Biol Chem.* 261 (1986) 9558-9563.
27. B. Papp, A. Enyedi, T. Kovacs, B. Sarkadi, F. Wuytack, O. Thastrup, G. Gárdos, R. Bredoux, S. Levy-Toledano, J. Enouf, Demonstration of two forms of calcium pumps by thapsigargin inhibition and radioimmunoblotting in platelet membrane vesicles, *J Biol Chem.* 266 (1991) 14593-14596.
28. P.A. Valant, D.H. Haynes, The Ca^{2+} -extruding ATPase of the human platelet creates and responds to cytoplasmic pH changes, consistent with a $2 \text{Ca}^{2+}/\text{nH}^{+}$ exchange mechanism, *J Membr Biol.* 136 (1993) 215-230.
29. P.A. Valant, P.N. Adjei, D.H. Haynes, Rapid Ca^{2+} extrusion via the $\text{Na}^{+}/\text{Ca}^{2+}$ exchanger of the human platelet, *J Membr Biol.* 130 (1992) 63-82.
30. V. Stamouli, C. Vakirtzi-Lemonias, W. Siffert, Thrombin and NaF, but not epinephrine, raise cytosolic free Na^{+} in human platelets, *Biochim Biophys Acta.* 1176 (1993) 215-221.
31. B. Somasundaram, M.J. Mason, M.P. Mahaut-Smith, Thrombin-dependent calcium signalling in single human erythroleukaemia cells, *J Physiol.* 501 (1997) 485–495.
32. Harper MT, Poole AW. Diverse functions of protein kinase C isoforms in platelet activation and thrombus formation. *J Thromb Haemost.* 8 (2010) 454-462.
33. T.M. Getz, A. Myanglamban, J.L. Daniel, S.P. Kunapuli, Go6976 abrogates GPVI-mediated platelet functional responses in human platelets through inhibition of Syk, *J Thromb Haemostas.* 9 (2011) 608-610.
34. W.-Y. Wang, Y.-C. Wu, C.-C. Wu, Prevention of glycoprotein IIb/IIIa activation by 3, 4-methylenedioxy- β -nitrostyrene, a novel tyrosine kinase inhibitor, *Mol Pharmacol.* 70 (2006) 1380-1389.
35. P. Sargeant, R.W. Farndale, S.O. Sage, The tyrosine kinase inhibitors methyl 2,5-dihydroxycinnamate and genistein reduce thrombin-evoked tyrosine phosphorylation and Ca^{2+} entry in human platelets, *FEBS Lett.* 315 (1993) 242-246.
36. P. Sargeant, R.W. Farndale, S.O. Sage, ADP- and thapsigargin-evoked Ca^{2+} entry and protein-tyrosine phosphorylation are inhibited by the tyrosine kinase inhibitors genistein and methyl-2,5-dihydroxycinnamate in fura-2-loaded human platelets, *J Biol Chem.* 268 (1993) 18151-18156.
37. M.P. Reilly, U. Sinha, P. André, S.M. Taylor, Y. Pak, F.R. Deguzman, N. Nanda, A. Pandev, M. Stolla, W. Bergmeier, S.E. McKenzie, PRT-060318, a novel Syk inhibitor, prevents heparin-induced thrombocytopenia and thrombosis in a transgenic mouse model, *Blood* 117 (2011) 2241-2246.
38. D.C. Cole, M. Asselin, A. Brennan, R. Czerwinski, J.W. Ellingboe, L. Fitz, R. Greco, X. Huang, D. Joseph-McCarthy, M.F. Kelly, M. Kirisits, J. Lee, Y. Li, P. Morgan, J.R. Stock, D.H. H. Tsao, A. Wissner, X. Yang, and D. Chaudhary, Identification, Characterization and Initial Hit-to-Lead Optimization of a Series of 4-Arylamino-3-

- Pyridinecarbonitrile as Protein Kinase C theta (PKC θ) Inhibitors, *J Med Chem.* 51 (2008) 5958-5963.
39. M.A. Packham, A.A. Livne, D.H. Ruben, M.L. Rand, Activation of phospholipase C and protein kinase C has little involvement in ADP-induced primary aggregation of human platelets: effects of diacylglycerols, the diacylglycerols, the diacylglycerol kinase inhibitor R59022, staurosporine and okadaic acid, *Biochem J.* 290 (1993) 849-856.
 40. E.M. Duncan, L.J. Tonbridge, J.V. Lloyd, An increase in phosphatidic acid in the absence of changes in diacylglycerol in human platelets stimulated with ADP, *Int J Biochem* 25 (1993) 23-27.
 41. J.J. Baldassare, P.A. Henderson, D. Burns, C. Loomis, G.J. Fisher, Translocation of protein kinase C isozymes in thrombin-stimulated human platelets. Correlation with 1,2-diacylglycerol levels, *J Biol Chem.* 267 (1992) 15585-15590.
 42. C.P. Wheeler-Jones, Y. Patel, V.V. Kakkar, S. Krishnamurthi, Receptor- and phorbol-ester-mediated redistribution of protein kinase C in human platelets. Evidence that aggregation promotes degradation of protein kinase C, *Biochem J.* 263 (1989) 969-972.
 43. A.J. Unsworth, H. Smith, P. Gissen, S.P. Watson and C.J. Pears, Submaximal inhibition of protein kinase C restores ADP-induced dense granule secretion in platelets in the presence of Ca²⁺, *J Biol Chem.* 286 (2011) 21073-21082.
 44. K. Gilio, M.T. Harper, J.M.E.M. Cosemans, O. Konopatskaya, I.C.A. Munnix, L. Prinzen, M. Leitges, Q. Liu, J.D. Molkenin, J.W.M. Heemskerk and A.W. Poole, Functional divergence of platelet protein kinase C (PKC) isoforms in thrombus formation on collagen, *J Biol Chem.* 285 (2010) 23410-23419.
 45. S. Muragappan, F. Tuluc, R.T. Dorsam, H. Shankar, S.P. Kunapuli, Differential Role of Protein Kinase C δ Isoform in Agonist-induced Dense Granule Secretion in Human Platelets, *J Biol Chem.* 279 (2004) 2360-2367.
 46. Y.M. Usachev, A.J. Marsh, T.M. Johanns, M.M. Lemke, S.A. Thayer, Activation of protein kinase C in sensory neurons accelerates Ca²⁺ uptake into the endoplasmic reticulum, *J Neurosci.* 26 (2006) 311-318.
 47. A.H. Qureshi, V. Chaoji., D. Maignel, M.H. Faridi, C.J. Barth, S.M. Salem, M. Singhal, D. Stoub, B. Krastins, M. Ogihara, M.J. Zaki, V. Gupta, Proteomic and Phospho-Proteomic Profile of Human Platelets in Basal, Resting State: Insights into Integrin Signaling, *PLOS One.* 4 (2009) e7627.
 48. B. Franke, M. van Triest, K.M. de Bruijn, G. van Willigen, H.K. Nieuwenhuis, C. Negrier, J.W. Akkerman, J.L. Bos, Sequential regulation of the small GTPase Rap1 in human platelets, *Mol Cell Biol.* 20 (2000) 779-785.
 49. B. Bernardi, G.F. Guidetti, F. Campus, J.R. Crittenden, A.M. Graybiel, C. Balduini, M. Torti, The small GTPase Rap1b regulates the cross talk between platelet integrin alpha2beta1 and integrin alphaIIb beta3, *Blood.* 107 (2006) 2728-2735.

50. A. Darnanville, R. Bredoux, K.J. Clemetson, N. Kieffer, N. Bourdeau, S. Levy-Toledano, J.P. Caen, J. Enouf, The phosphoprotein that regulates platelet Ca^{2+} transport is located on the plasma membrane, controls membrane-associated Ca^{2+} -ATPase and is not glycoprotein Ib beta-subunit, *Biochem J.* 273 (1991) 429-434.
51. E. Corvazier, J. Enouf, B. Papp, J. de Gunzburg, A. Tavitian, S. Levy-Toledano, Evidence for a role of rap1 protein in the regulation of human platelet Ca^{2+} fluxes, *Biochem J.* 281 (1992) 325-331.
52. C. Magnier, E. Corvazier, M.C. Aumont, T.H. Le Jemtel, J. Enouf, Relationship between Rap1 protein phosphorylation and regulation of Ca^{2+} transport in platelets: a new approach. *Biochem J.* 310 (1995) 469-475.
53. K. Dey, S. Roy, B. Ghosh, S. Chakraborti, Role of protein kinase C in phospholemman mediated regulation of $\alpha_2\beta_1$ isozyme of Na^+/K^+ -ATPase in caveolae of pulmonary artery smooth muscle cells, *Biochimie.* 94 (2012) 991-1000.
54. F. Han, J. Bossuyt, J.L. Martin, S. Despa, D.M. Bers, Role of phospholemman phosphorylation sites in mediating kinase-dependent regulation of the Na^+/K^+ -ATPase, *Am J Physiol.* 299 (2010) C1363-1369.
55. K. Geering, FXYD proteins: new regulators of Na^+/K^+ -ATPase, *Am J Physiol.* 290 (2006) F241-250.
56. J.M. Burkhart, M. Vaudel, S. Gambaryan, et al., The first comprehensive and quantitative analysis of human platelet protein composition allows the comparative analysis of structural and functional pathways, *Blood.* 120 (2012) e73-e82.
57. T. Bork, R.J. Mrsny, Appearance of additional ouabain binding sites on platelet surfaces following activation, *Exp Cell Res.* 208 (1993) 189-196.

Figure 1

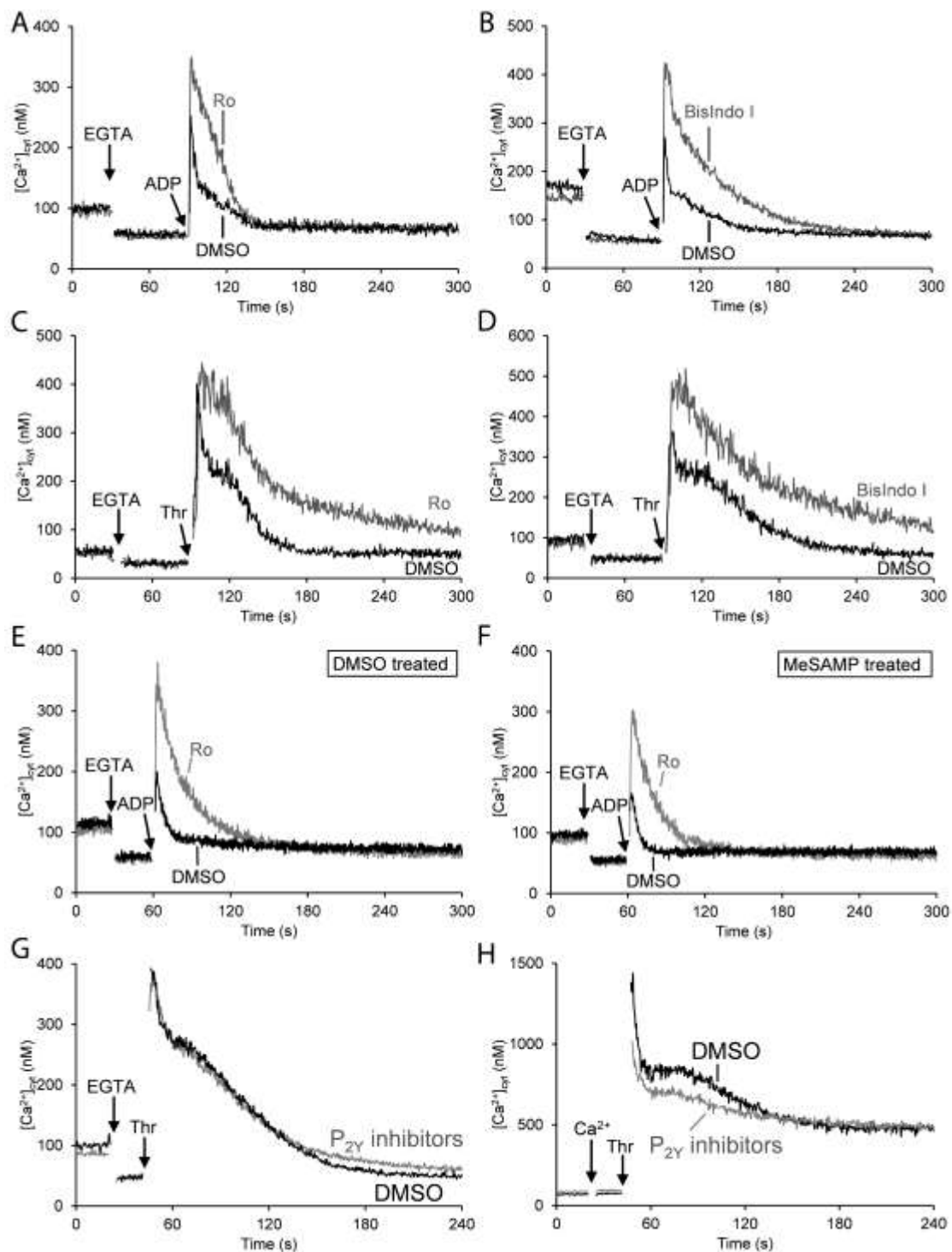

Fig. 1. PKC inhibitors potentiate ADP- and thrombin-evoked increases in $[Ca^{2+}]_{cyt}$. Fura-2-loaded human platelets were suspended in supplemented HBS containing 200 μ M $CaCl_2$, and preincubated with either 10 μ M Ro-31-8220 (A,C, E, F), 5 μ M BisIndo I (B, D), 75 μ M MeSAMP (F), 75 μ M MesAMP and 75 μ M MRS-2179 (G,H) or their vehicle, DMSO as indicated, for 10 min at 37°C. Extracellular Ca^{2+} was then chelated by addition of 1 mM EGTA (A-G) or extracellular Ca^{2+} was raised to 1 mM by addition of 800 μ M $CaCl_2$ (H) before the platelets were stimulated with 50 μ M ADP (A, B, E, F) or 0.5 units ml^{-1} thrombin (C, D, G, H)

Figure 2

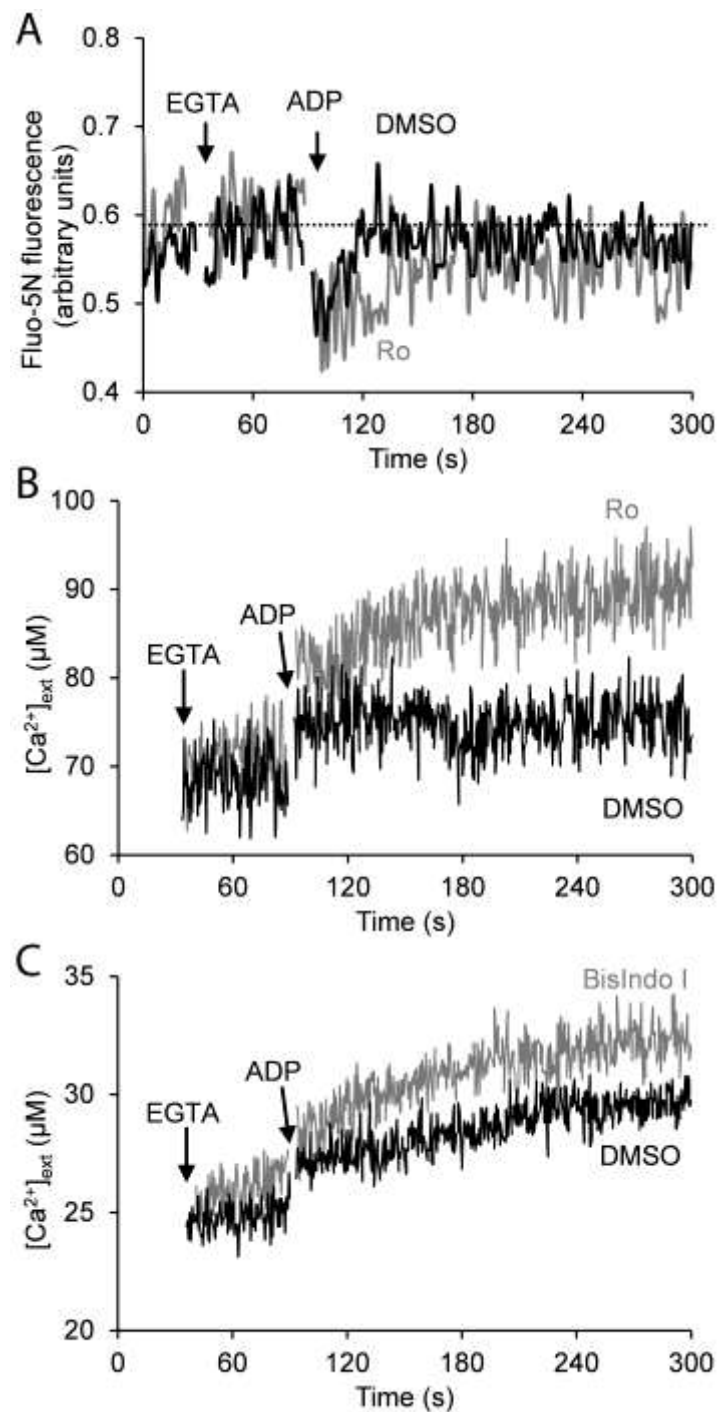

Fig. 2. PKC inhibitors potentiate ADP-evoked intracellular Ca^{2+} release and Ca^{2+} removal into the extracellular medium. A. Fluo-5N –loaded human platelets were suspended in supplemented HBS containing $200 \mu\text{M}$ CaCl_2 and preincubated with $10 \mu\text{M}$ Ro-31-8220 or the vehicle, DMSO, for 10 min at 37°C . Extracellular Ca^{2+} was then chelated by addition of 1 mM EGTA before the platelets were stimulated with $50 \mu\text{M}$ ADP. B, C. Washed human platelets were suspended in a supplemented HBS containing $200 \mu\text{M}$ CaCl_2 , and preincubated with either $10 \mu\text{M}$ Ro-31-8220 (B), $5 \mu\text{M}$ BisIndo I (C) or their vehicle, DMSO, for 10 min at 37°C . $2.5 \mu\text{M}$ Fluo-4 K^+ salt was then added immediately prior to the start of the experiments. Extracellular Ca^{2+} was chelated by addition of 1 mM EGTA and the platelets were then stimulated with $50 \mu\text{M}$ ADP.

Figure 3

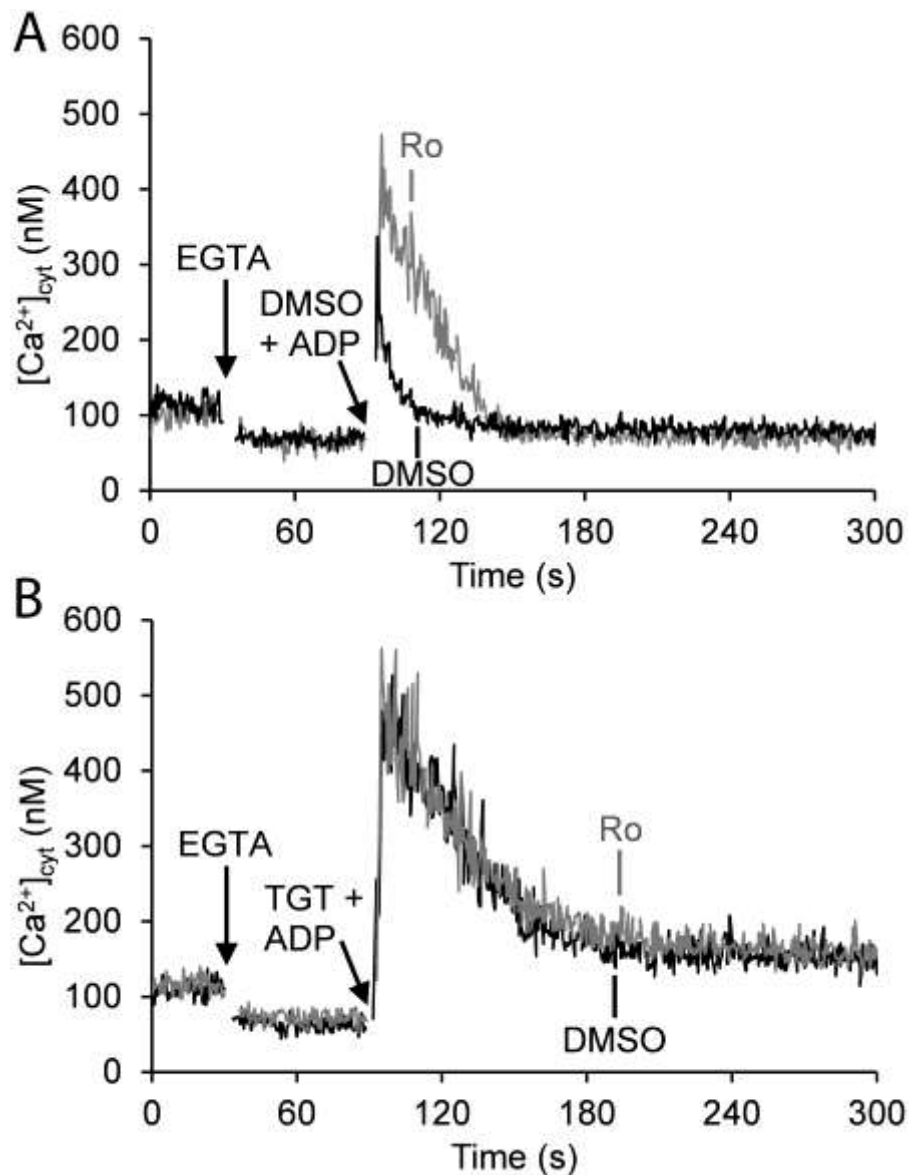

Fig. 3. SERCA inhibition abolishes the effect of PKC inhibitors on ADP- evoked changes in $[Ca^{2+}]_{cyt}$. Fura-2-loaded human platelets were suspended in supplemented HBS containing 200 μ M $CaCl_2$ and preincubated with 10 μ M Ro-31-8220 or its vehicle, DMSO, for 10 minutes at 37°C. Extracellular Ca^{2+} was then chelated by addition of 1 mM EGTA and the platelets stimulated with 50 μ M ADP and either both SERCA inhibitors, 1 μ M thapsigargin and 20 μ M TBHQ (TGT), or an equal volume of their vehicle, DMSO.

Figure 4

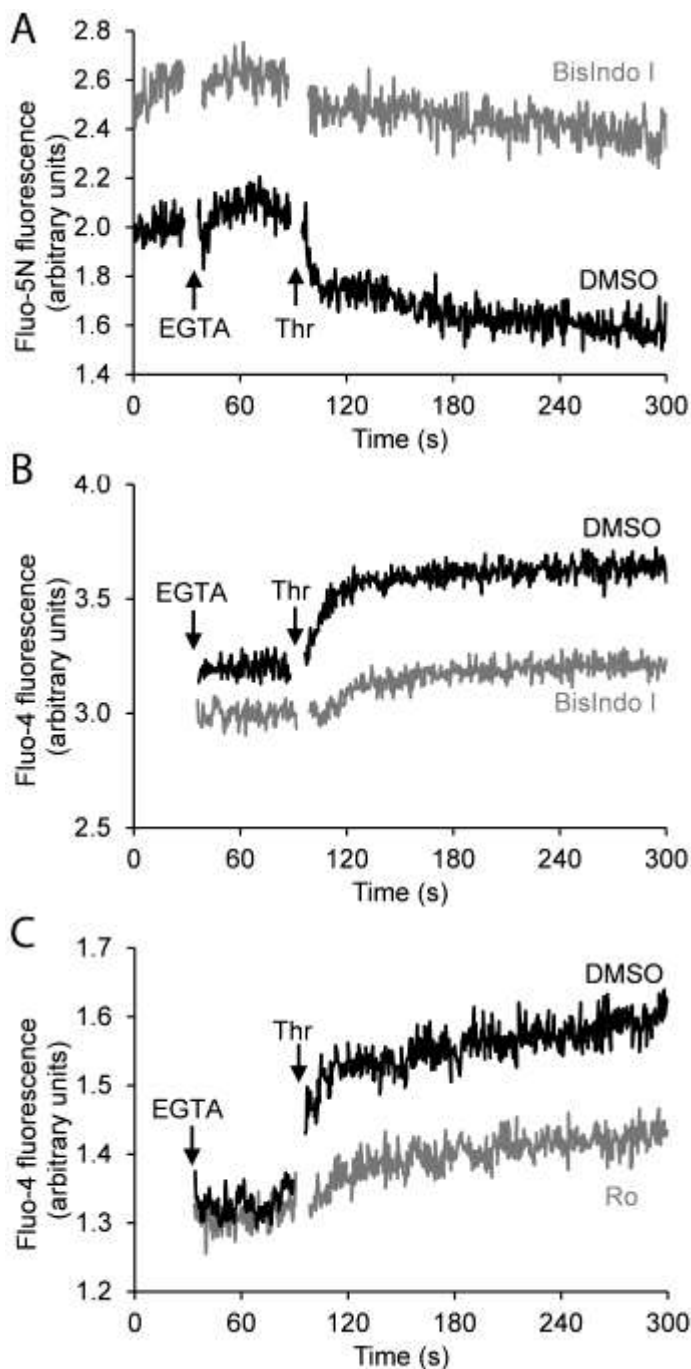

Fig. 4. PKC inhibitors inhibit thrombin-evoked intracellular Ca^{2+} release and Ca^{2+} removal into the extracellular medium. A. Fluo-5N-loaded human platelets were suspended in supplemented HBS containing $200 \mu\text{M}$ CaCl_2 and preincubated with $10 \mu\text{M}$ Ro-31-8220 or the vehicle, DMSO, for 10 min at 37°C . Extracellular Ca^{2+} was then chelated by addition of 1 mM EGTA before the platelets were stimulated with $0.5 \text{ units ml}^{-1}$ thrombin. B, C. Washed human platelets were suspended in a supplemented HBS containing $200 \mu\text{M}$ CaCl_2 , and preincubated with either $10 \mu\text{M}$ Ro-31-8220 (B), $5 \mu\text{M}$ BisIndo I (C) or their vehicle, DMSO, for 10 min at 37°C . $2.5 \mu\text{M}$ Fluo-4 K^+ salt was then added immediately prior to the start of the experiments. Extracellular Ca^{2+} was chelated by addition of 1 mM EGTA and the platelets were then stimulated with $0.5 \text{ units ml}^{-1}$ thrombin.

Figure 5

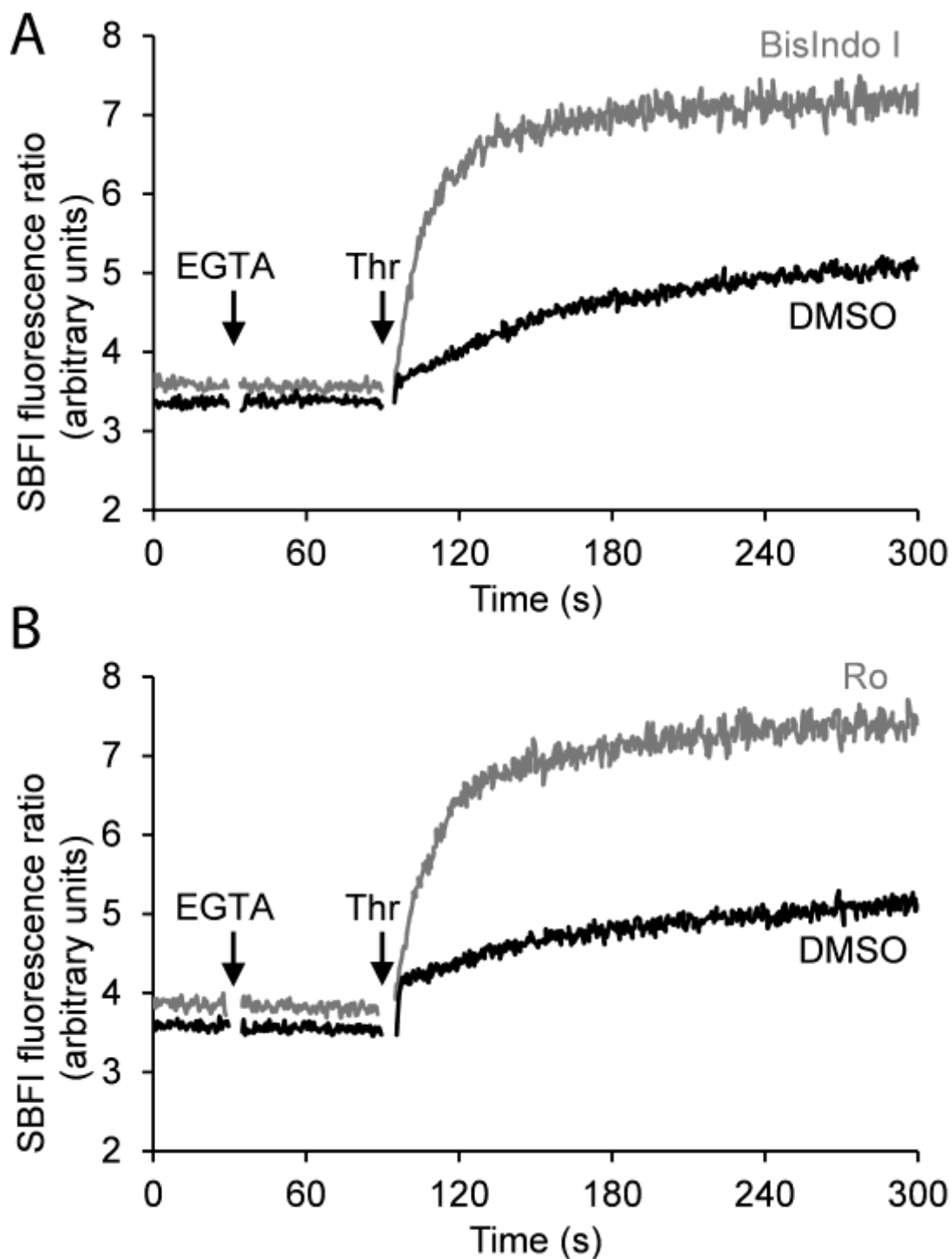

Fig. 5. PKC inhibitors potentiate thrombin-evoked changes in $[Na^+]_{cyt}$. SBFi-loaded human platelets were suspended in supplemented HBS containing 200 μ M $CaCl_2$ and preincubated with either 5 μ M BisIndo I (A), 10 μ M Ro-31-8220 (B) or their vehicle, DMSO, for 10 min at 37°C. Extracellular Ca^{2+} was then chelated by addition of 1 mM EGTA and the platelets were then stimulated with 0.5 units ml^{-1} thrombin.

Figure 6

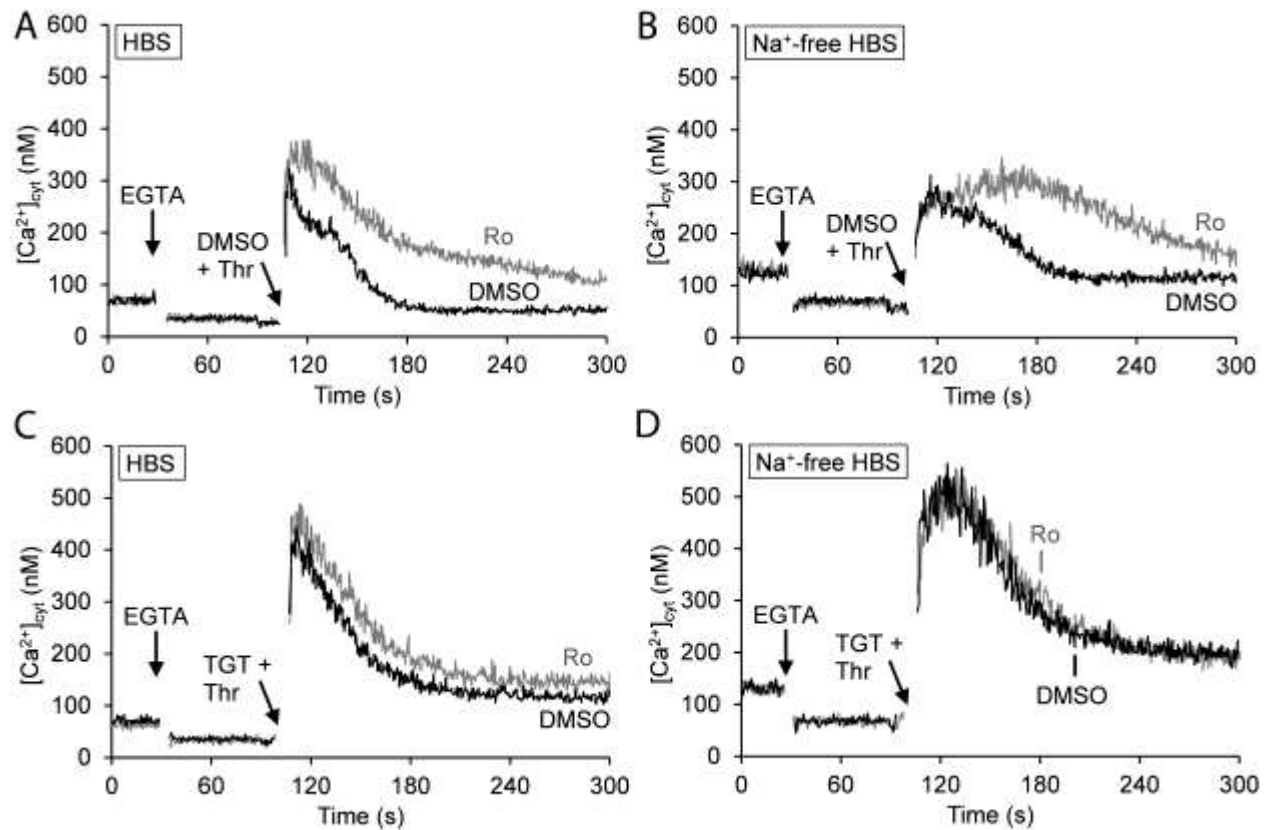

Fig. 6. PKC inhibitors are without effect on thrombin-evoked rises in $[Ca^{2+}]_{cyt}$ following SERCA inhibition and removal of extracellular Na^+ . Fura-2-loaded human platelets were suspended in supplemented HBS (A, C) or a similar medium in which Na^+ was replaced with NMDG (B, D) containing 200 μM $CaCl_2$ and preincubated with 10 μM Ro-31-8220 or its vehicle, DMSO, for 10 min at 37°C. Extracellular Ca^{2+} was then chelated by addition of 1 mM EGTA and the platelets stimulated with 0.5 units ml^{-1} thrombin and either both 1 μM thapsigargin and 20 μM TBHQ (TGT), or an equal volume of their vehicle, DMSO.

Figure 7

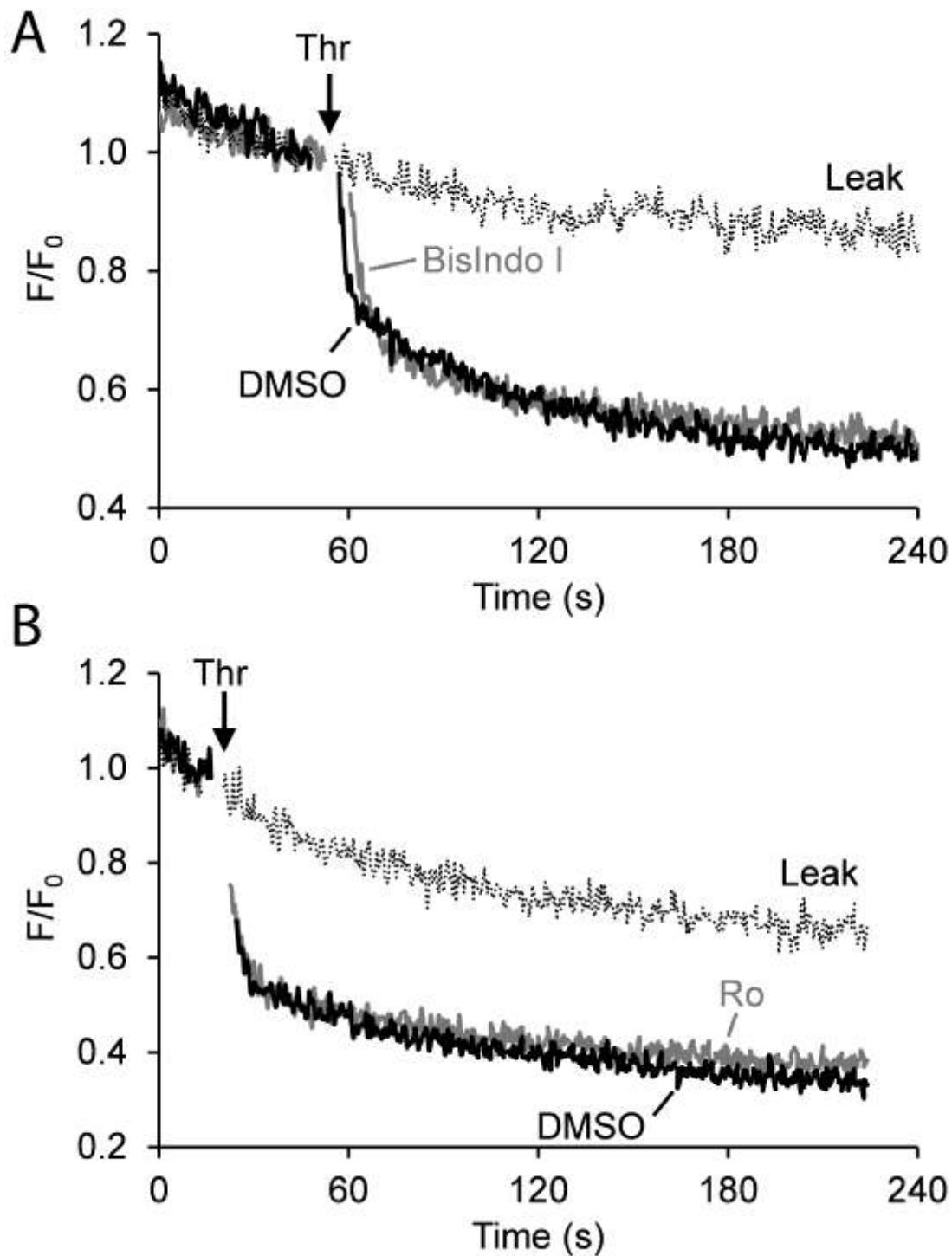

Fig. 7. PKC inhibitors have no effect on the thrombin-evoked opening of non-selective cation channels. Fura-2-loaded human platelets were suspended in a Ca^{2+} -free medium, and preincubated with either 5 μM BisIndo I (A), 10 μM Ro-31-8220 (B) or their vehicle, DMSO (A,B), for 10 min at 37°C. 500 μM EGTA was then added followed by the addition of 1 mM MnCl_2 . Platelets were then stimulated with 0.5 units ml^{-1} thrombin. An unstimulated control sample is also shown in both panels

Figure 8

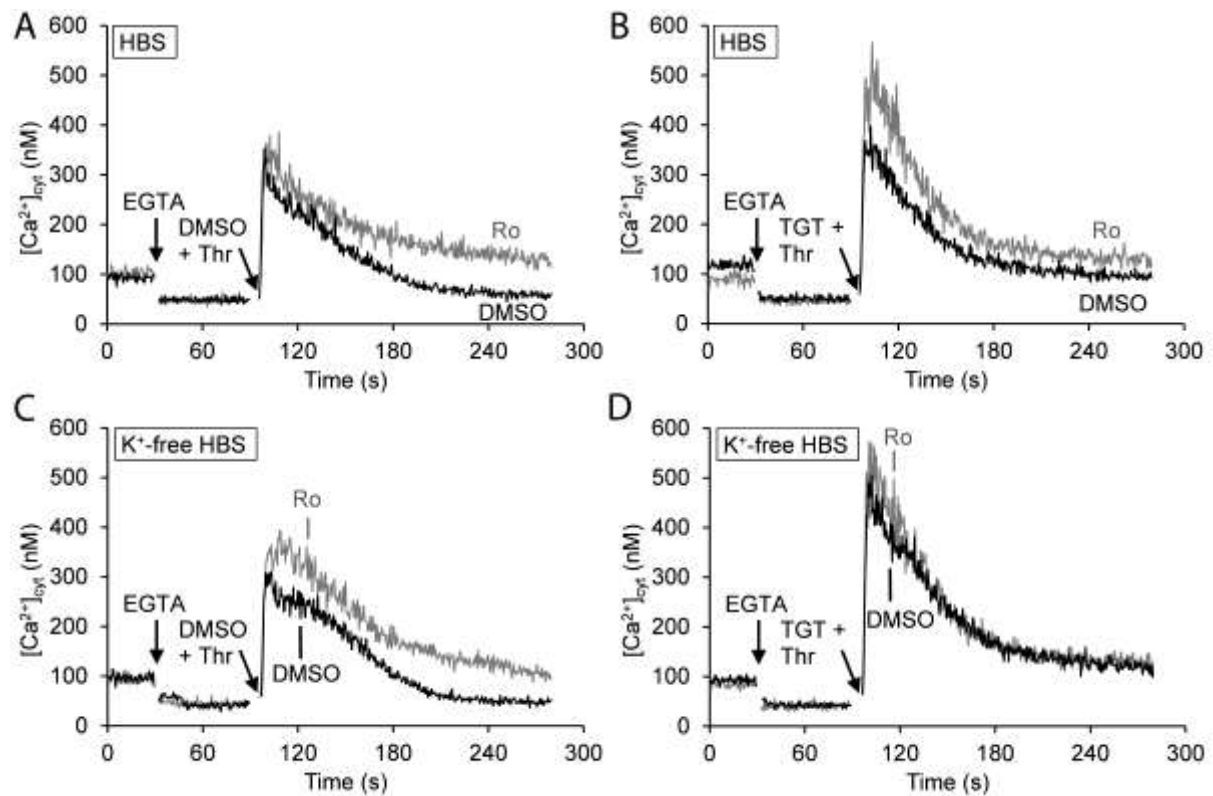

Fig. 8. PKC inhibitors are without effect on thrombin-evoked rises in $[Ca^{2+}]_{\text{cyt}}$ following SERCA and Na^+/K^+ -ATPase inhibition by removal of extracellular K^+ . Fura-2-loaded human platelets were suspended in supplemented HBS (A, C) or a similar medium in which K^+ was replaced with Na^+ (B, D) containing $200 \mu\text{M}$ $CaCl_2$ and preincubated with $10 \mu\text{M}$ Ro-31-8220 or its vehicle, DMSO, for 10 min at 37°C . Extracellular Ca^{2+} was then chelated by addition of 1 mM EGTA and the platelets stimulated with $0.5 \text{ units ml}^{-1}$ thrombin and either both $1 \mu\text{M}$ thapsigargin and $20 \mu\text{M}$ TBHQ (TGT), or an equal volume of their vehicle, DMSO.

Figure 9

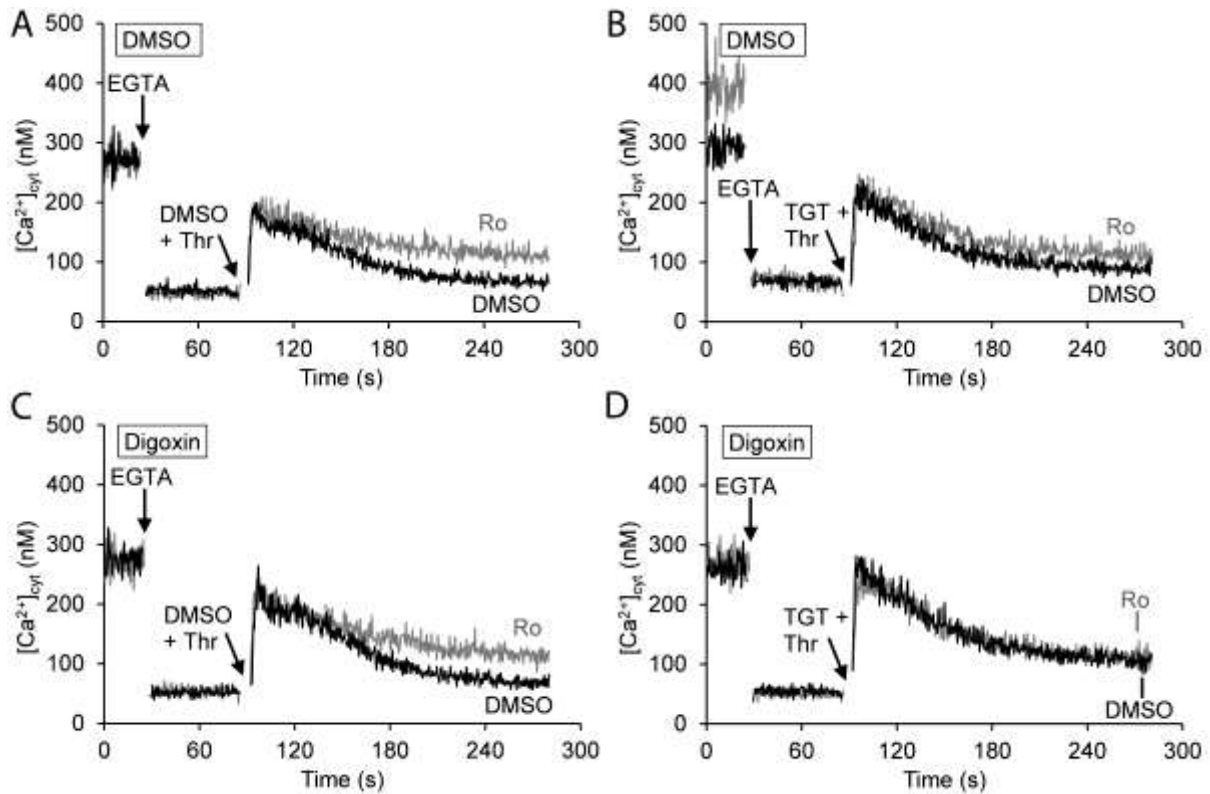

Fig. 9. PKC inhibitors are without effect on thrombin-evoked rises in $[Ca^{2+}]_{cyt}$ following SERCA and Na^+/K^+ -ATPase inhibition using digoxin. Fura-2-loaded human platelets were suspended in supplemented HBS containing 200 μ M $CaCl_2$ and preincubated with 100 μ M digoxin (C, D) or its vehicle, DMSO (A, B), for 1 h at 37°C and 10 μ M Ro-31-8220 or its vehicle, DMSO, for 10 min at 37°C. Extracellular Ca^{2+} was then chelated by addition of 1 mM EGTA and the platelets stimulated with 0.5 units ml^{-1} thrombin and either both 1 μ M thapsigargin and 20 μ M TBHQ (TGT; B, D), or an equal volume of their vehicle, DMSO (A, C).

Figure 10

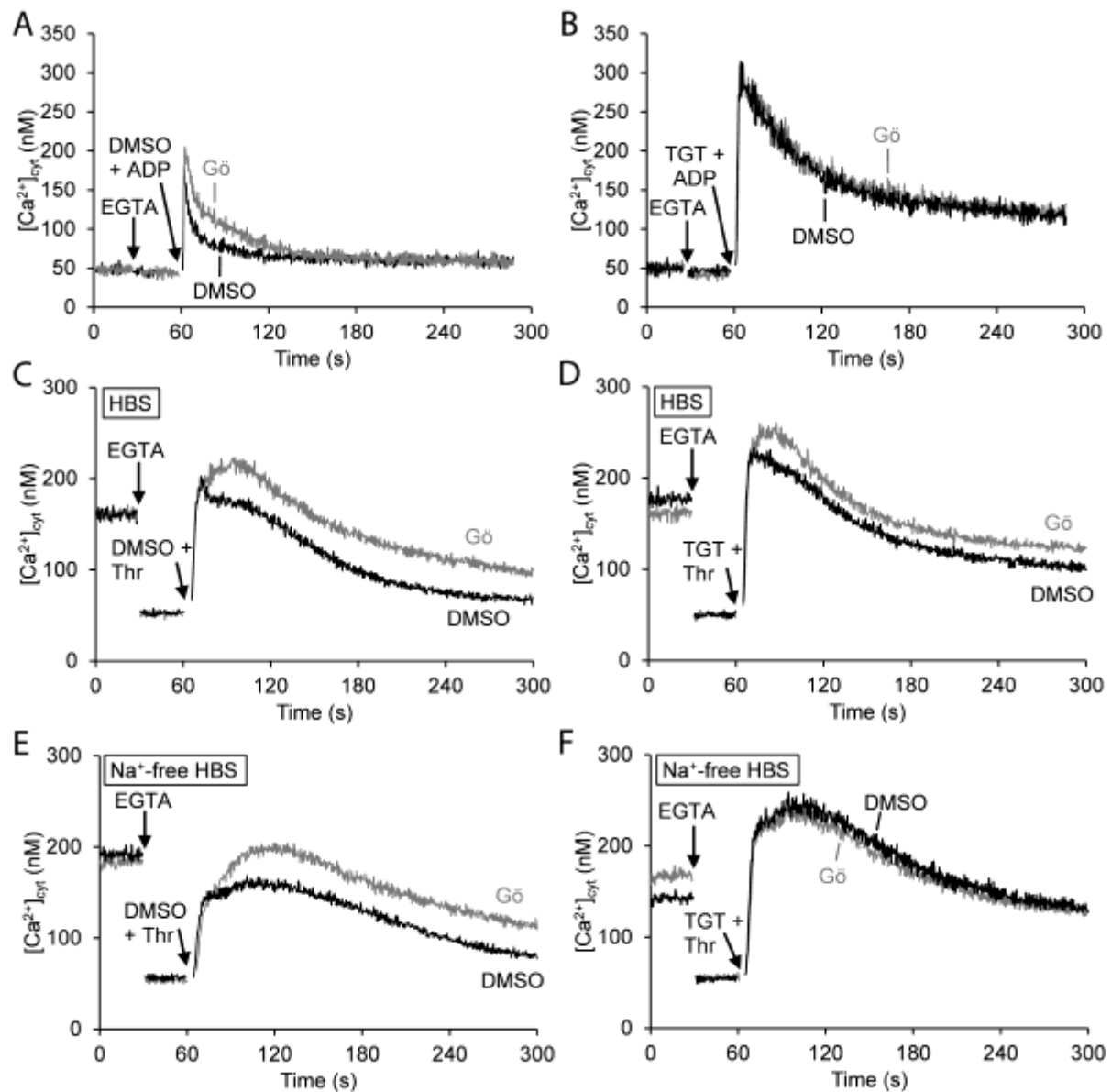

Fig. 10. The conventional PKC isoform inhibitor Gö6976 potentiates ADP- and thrombin-evoked rises in $[Ca^{2+}]_{cyt}$. Fura-2-loaded human platelets were suspended in supplemented HBS (A-D) or a similar medium in which Na^+ was replaced with NMDG (E, F) containing 200 μM $CaCl_2$ and preincubated with 3 μM Gö6976 or its vehicle, DMSO, for 10 min at 37°C. Extracellular Ca^{2+} was then chelated by addition of 1 mM EGTA and the platelets stimulated with 50 μM ADP (A, B) or 0.5 units ml^{-1} thrombin (C-F) and either both 1 μM thapsigargin and 20 μM TBHQ (TGT; B, D, F), or an equal volume of their vehicle, DMSO (A, C, E).

Figure 11

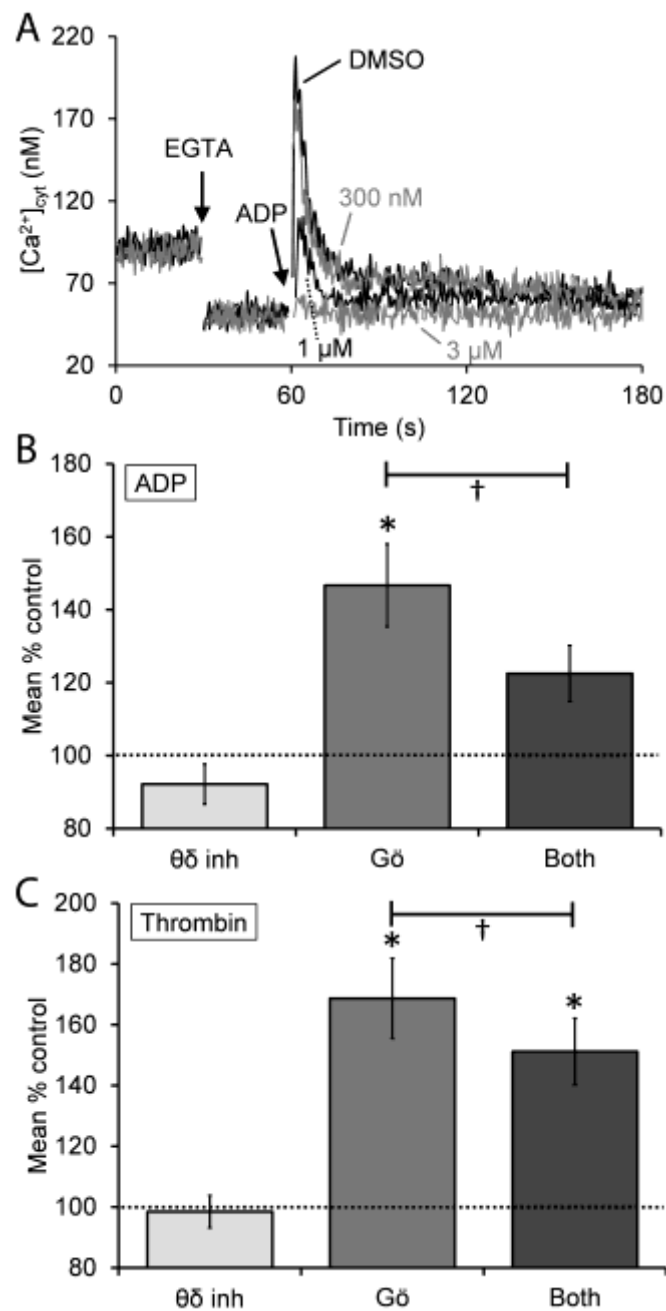

Fig. 11. The novel PKC isoform (PKC θ/δ inhibitor) does not potentiate ADP- or thrombin-evoked rises in $[Ca^{2+}]_{\text{cyt}}$. (A) Fura-2-loaded human platelets were suspended in supplemented HBS containing 200 μM CaCl_2 , and preincubated with 100 nM, 300 nM, 1 μM or 3 μM PKC θ/δ inhibitor or its vehicle, DMSO, for 10 min at 37°C. Extracellular Ca^{2+} was then chelated by addition of 1 mM EGTA before the platelets were stimulated with 50 μM ADP. (B, C) Fura-2-loaded human platelets were suspended in supplemented HBS containing 200 μM CaCl_2 , and preincubated with 300 nM PKC θ/δ inhibitor, 3 μM G δ 6976, both inhibitors or their vehicle, DMSO, for 10 min at 37°C. Extracellular Ca^{2+} was then chelated by addition of 1 mM EGTA before the platelets were stimulated with 50 μM ADP (B) or 0.5 units ml^{-1} thrombin. Results are expressed as mean of percentage control responses. * = $P < 0.05$ v. control, † = $P < 0.05$.

Figure 12

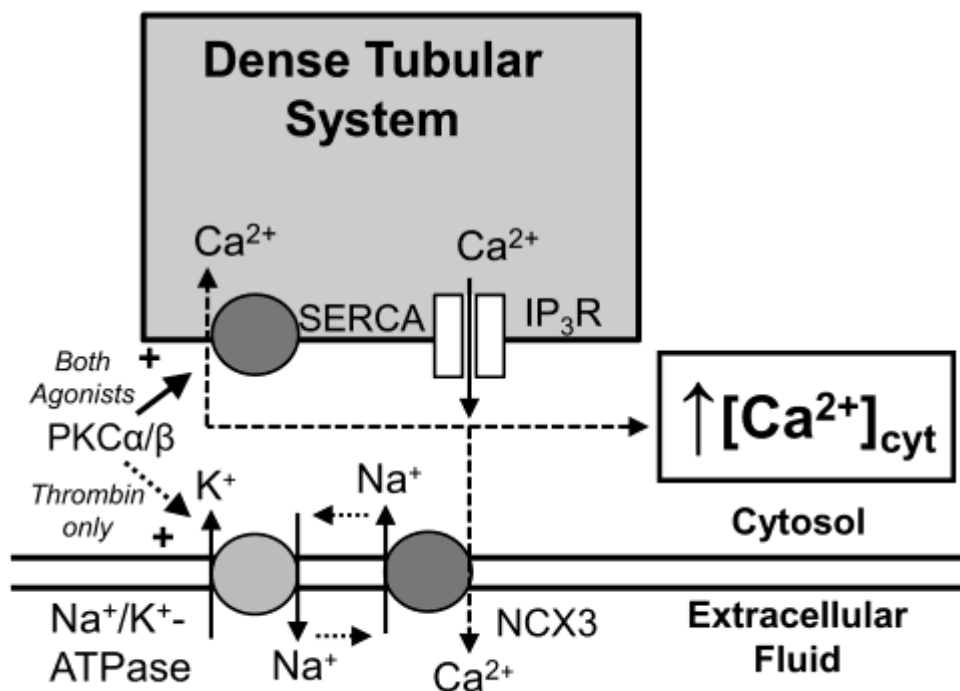

Fig. 12. Model for proposed effects of PKC in controlling ADP- and thrombin-evoked Ca^{2+} signalling in human platelets. The agonist-evoked rise in $[Ca^{2+}]_{cyt}$ is controlled by the conventional protein kinase C isoforms, PKC α and PKC β , by altering the rate of Ca^{2+} removal into the extracellular fluid and Ca^{2+} sequestration into intracellular stores in an agonist-dependent manner. Upon ADP activation, PKC negatively regulates the Ca^{2+} signal by increasing Ca^{2+} sequestration back into the dense tubular system through activation of SERCA. Upon thrombin stimulation, PKC additionally regulates Ca^{2+} removal from the cytosol into the extracellular space by increasing the activity of the Na⁺/K⁺-ATPase. This in turn limits agonist-evoked rises in $[Na^+]_{cyt}$, which slows Ca^{2+} efflux via forward mode Na⁺/Ca²⁺ exchange.